



Grandstream Networks, Inc.

GXV300x Series IP Video Phone



TABLE OF CONTENTS
GXV300X USER MANUAL

WELCOME	2
GXV3000X SERIES OVERVIEW	2
INSTALLATION	3
CONNECTING YOUR GXV IP VIDEO PHONE	4
WALL MOUNT.....	5
PRODUCT OVERVIEW.....	6
USING GXV300X IP VIDEO PHONE	9
GETTING FAMILIAR WITH LCD	9
MULTIPLE SIP ACCOUNTS AND LINES	12
MAKING PHONE CALLS	15
CALL FEATURES.....	18
CONFIGURATION GUIDE.....	19
CONFIGURE OPERATION WITH KEYPAD	19
CONFIGURATION WITH WEB BROWSER	22
END USER CONFIGURATION.....	24
ADVANCED USER CONFIGURATION.....	26
INDIVIDUAL ACCOUNT SETTINGS.....	33
CONFIGURATION THROUGH SECURE CENTRAL PROVISIONING SERVER.....	40
SOFTWARE UPGRADE & CUSTOMIZATION	41
FIRMWARE UPGRADE THROUGH TFTP/HTTP	41
CONFIGURATION FILE DOWNLOAD.....	42
GXV CUSTOMIZATION	44
XML PHONEBOOK	44
SCREENSAVER IMAGES	46
CUSTOMIZED RING TONES.....	48
AUXILIARY PORTS.....	49
VIDEO SURVEILLANCE.....	52
RESTORE FACTORY DEFAULT SETTING.....	55

TABLE OF FIGURES
GXV300X USER MANUAL

Figure 1: Connecting the GXV300x	4
Figure 2: GXV LCD Screen.....	9
Figure 3: Getting Familiar with Keypad.....	10
Figure 4: Configure Menu Options.....	19
Figure 5: Flow Chart of Key Pad Configuration Menu	20
Figure 6: Sizing the ScreenSaver	46
Figure 7: Screenshot of Screensaver Utility.....	47
Figure 8: Screenshot of Ring Tone Generating Utility	48
Figure 9: TV / GXV300x Diagram	49
Figure 10: Headset Jack Diagram	50
Figure 11: Headset Cross-over Diagrams	51
Figure 12: Screenshot – Monitoring Station.....	53

TABLE OF TABLES
GXV300X USER MANUAL

Table 1: Definitions of the GXV-300x Connectors	4
Table 2: GXV300x Product Models.....	6
Table 3: GXV300x Key Features in a Glance	6
Table 4: Hardware Specifications	6
Table 5: GXV-300x Technical Specifications.....	7
Table 6: LCD Icon Definitions	9
Table 7: GXV Button Definitions	11
Table 8: GXV300x Call Features	18
Table 9: Key Pad Configuration Menu	21
Table 10: Status Page Definitions.....	23
Table 11: Basic Configuration Definitions	24
Table 12: Advanced Settings Configuration Page Definitions	27
Table 13: SIP Account Configuration Page Definitions	33
Table 14: FXO Configuration Page Definitions	37
Table 15: FXS Configuration Page Definitions	38

CONFIGURATION GUI INTERFACE EXAMPLES
GXV300x WEB GUI

http://www.grandstream.com/support/gxv_series_phone/gxv300x/documents/gxv300x_gui.zip

1. SCREENSHOT OF CONFIGURATION LOGIN PAGE
 2. SCREENSHOT OF STATUS CONFIGURATION PAGE
 3. SCREENSHOT OF BASIC SETTINGS CONFIGURATION PAGE
 4. SCREENSHOT OF ACCOUNT1 CONFIGURATION
 5. SCREENSHOT OF ADVANCED USER CONFIGURATION PAGE
 6. SCREENSHOT OF SAVED CONFIGURATION CHANGES
 7. SCREENSHOT OF REBOOT PAGE
 8. SCREENSHOT OF FXO SETTINGS CONFIGURATION PAGE
 9. SCREENSHOT OF FXS SETTINGS CONFIGURATION PAGE
-

WELCOME

Thank you for purchasing the Grandstream GXV300x IP Video Phone. The GXV300x is a cost effective, easy to use and easy to configure IP video communications solution. The GXV300x supports popular voice codecs and H.264, H.263/H.263+ video codec. It is based on SIP industry standard and interoperable with 3rd party SIP providers, thus enabling you to fully leverage the benefits of VoIP technology, while visually commuting with anyone, anywhere in world.

This manual will help you learn how to operate and manage your GXV IP Video Phone and make the best use of its many upgraded features including simple and quick installation, multi-party conferencing, and direct IP-IP Calling.

GXV300X SERIES OVERVIEW

Currently, the GXV300x IP Video Phone series consists of the following three models: GXP3000, GXV3005 and GXV3006.

The GXV300x series is a next generation IP video phone based on SIP standard and H.264 video codec, the codec of choice for high-quality video. It also supports H.263/H.263+ legacy video codec just for compatibility. The GXV300x supports real-time (up to 30fps) high-quality video at very modest bandwidth level (as low as 32kbps, up to 1Mbps). The phone allows nearly all viewing angles via a large 5.6" TFT adjustable LCD screen and a VGA camera, creating high-quality videoconferences from your desk.

The GXV300x combines great design and technology with excellent audio and picture quality, ease of use and broad interoperability with 3rd party SIP products. It is ideal for any multi-media communication environment, the virtual office and all IP video communications for business or residential users.

Caution: *Changes or modifications to this product not expressly approved by Grandstream, or operation of this product in any way other than as detailed by this User Manual, could void your (one year) manufacturer warranty.*

- This document is contains links to Grandstream GUI Interfaces. Please remember to download these examples http://www.grandstream.com/support/gxv_series_phone/gxv300x/documents/gxv300x_gui.zip for your reference.
- This document is subject to change without notice. The latest electronic version of this user manual is available for download from the following location: http://www.grandstream.com/support/gxv_series_phone/gxv300x/documents/gxv300x_usermanual_english.pdf
- *Reproduction or transmittal of any part, in any form or by any means, electronic or print, for any purpose without the express written permission of Grandstream Networks, Inc. is not permitted.*

INSTALLATION

Unpack and check all accessories. Equipment included in the package:

The GXV300x IP Video Phone package contains:

1. One GXV300x Main Case
2. One Handset
3. One Phone Cord
4. One Universal Power Adaptor
5. One Ethernet Cable
6. Two Wall Mount Sustaining Brackets

SAFETY COMPLIANCES

The GXV300x phone complies with FCC/CE and various safety standards. The GXV300X power adaptor is compliant with UL standard. Only use the universal power adapter provided with the GXV package. The manufacturer's warranty does not cover damages to the phone caused by unsupported power adaptors.

WARRANTY

If you purchased your GXV300x from a reseller, please contact the company where you purchased your phone for replacement, repair or refund. If you purchased the product directly from Grandstream, contact your Grandstream Sales and Service Representative for a RMA (Return Merchandise Authorization) number before you return the product. Grandstream reserves the right to remedy warranty policy without prior notification.

Warning: *Please do not attempt to use a different power adaptor. Using other power adaptor may damage the GXV300x and will void the manufacturer warranty.*

CONNECTING YOUR GXV IP VIDEO PHONE

FIGURE 1: CONNECTING THE GXV300X

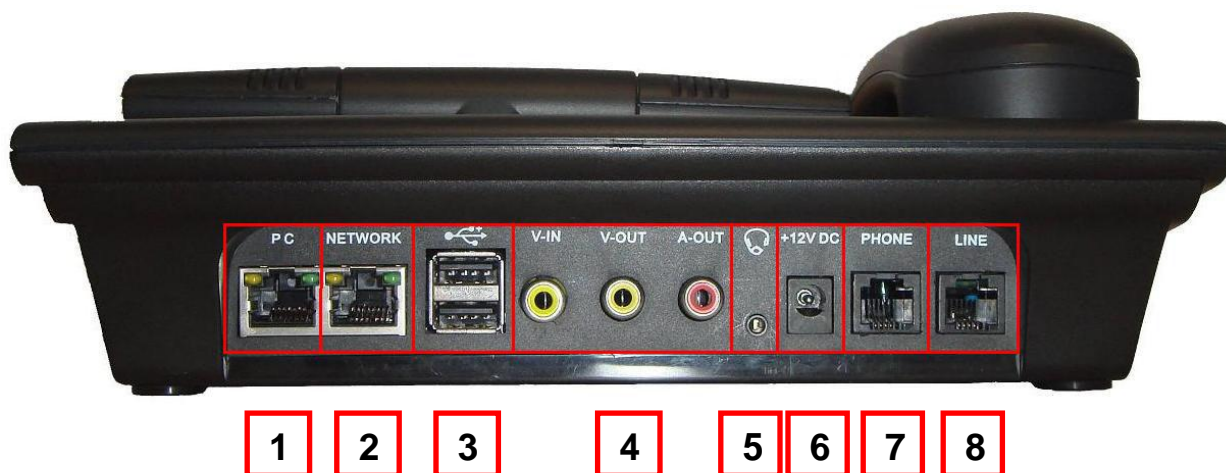

TABLE 1: DEFINITIONS OF THE GXV-300X CONNECTORS

1	PC	10/100Mbps RJ-45 port for connecting PC as switch mode
2	LAN	10/100Mbps RJ-45 port for uplink to Ethernet.
3	USB	USB Interface for external USB device like flash to store captured snapshot image; USB keyboard and mouse for embedded mini web browser operations.
4	Video/Audio Jacks	RCA Output Interface to external display like TV set
5	Headset Jack	2.5mm headset jack
6	Power Jack	12V DC power port
7	PHONE (RJ11)	FXS port should be connected to analog phones. (Only applicable on GXV3006)
8	LINE (RJ-11)	FXO port should be connected to the PSTN line (Only applicable on GXV3005)

WALL MOUNT

GXV300x can be wall mounted. The two (2) wall mount sustaining brackets can be attached to the bottom of the main body:



To position the phone on the wall, place two fixed hangers on the wall, hang the back of the phone on the fixed hangers. The two sustaining brackets will balance the bottom of the phone and position the phone on the wall.

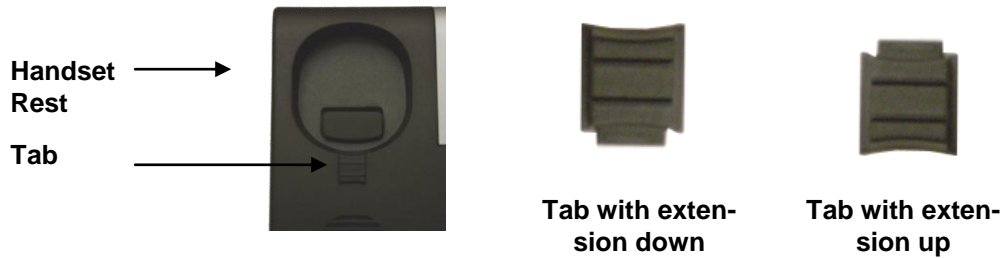

To use the handset, pull out the tab (extension downward) from the handset cradle, rotate the tab and plug it back into the slot with the *extension up* for to hold the handset.

PRODUCT OVERVIEW

Desktop View



Side View



Back View



Closed



TABLE 2: GXV300X PRODUCT MODELS

Model	Overview	P/N
GXV3000	-Three lines	xxx-xx 001 -xxx
GXV3005	-Three lines -One LINE(FXO/PSTN) port	xxx-xx 007 -xxx
GXV3006	-Three lines -One PHONE(FXS) port	xxx-xx 010 -xxx

Note: Digits of P/N which are marked in red identify the specific model.
For example: The device is a GXV3000 if the P/N number is 963-00**001**-42B

TABLE 3: GXV300X KEY FEATURES IN A GLANCE

Open Standards Compatible	SIP 2.0, TCP/IP/UDP, RTP/RTCP, HTTP/HTTPS, ARP/RARP, ICMP, DNS (A record and SRV), DHCP, PPPoE, TFTP, NTP.
Network Interfaces	Dual 10/100mbps Ethernet ports, 2 USB (2.0) host ports, 2.5mm headset jack.
Superb Audio Quality	Advanced Digital Signal Processing (DSP), Silence suppression, VAD, CNG, AEC, AGC.
Superb Video Quality	Supports H.263/H.263+ and H.264 (baseline) real-time video codec with video bandwidth from 32kbps – 1Mbps.
Advanced Video features	5.6in TFT color LCD, 180 degrees vertical rotation, 300 degrees horizontal rotation, advanced VGA resolution CMOS camera sensor, auto focus and exposure, auto zoom, camera block, PIP, still picture capture/store.
Feature Rich	Traditional voice features including caller ID, call waiting, hold, transfer, forward, DND, mute, autodial/off-hook dial, and embedded mini Browser.
Advanced Functionality	Multi-line support, multi-party conferencing (audio only), headset enabled, intercom, AES encryption.

TABLE 4: HARDWARE SPECIFICATIONS

Ethernet Port	Dual 10M/100M auto-sensing Ethernet ports function as a mini-switch
FXO telephone port (LINE Port)	1 FXO PSTN line port (RJ11) (This is only applicable on GXV3005)
FXS telephone port (PHONE port)	1 FXS PHONE port (RJ11) (This is only applicable on GXV3006)
LCD	5.6 inch TFT color LCD
Camera	Advanced CMOS sensor (VGA resolution)
Auxiliary Port	RCA style stereo audio & composite video output jack, one 2.5mm headset jack, two 2.0 USB ports

Exterior	Black or Silver ABS plastic, 30 buttons (6 of which are LED buttons)
Universal Power Supply	100-240V input, 12VDC/1.2A output, US/Euro/UK/Australian style plug available
Dimension	6.5cm x 18cm x 16cm
Weight	1.2kg
Operating Temperature	0°-40° C
Humidity	10 - 95% non-condensing
Compliance	FCC/CE/C-Tick

TABLE 5: GXV-300X TECHNICAL SPECIFICATIONS

Lines	3 individual SIP accounts; 3 line buttons
Protocol Support	Support SIP 2.0, UDP/IP, PPPoE, RTP/RTCP, SRTP by SDES, HTTP, ARP/RARP, ICMP, DNS, DHCP, NTP/SNTP, TFTP.
Display	5.6 inch TFT color LCD
Feature Keys	8 dedicated keys: Message Button, Hold, Transfer, Conference, Speakerphone, Send, Mute/Del, Camera Block 5 display/menu navigation keys
Network Interface	Dual (2) 10/100 auto-sensing Ethernet ports (switched) Support 2 USB (2.0) host ports, 1 audio and 1 video output jack (capable of outputting video to an external TV simultaneously), headset jack
Device Management	Support Layer 2 (IEEE 802.1p/Q tagging (VLAN) and Layer 3 QoS (DiffServ) Web interface or via secure (AES encrypted) central configuration file for mass deployment, Keypad & adjustable 5.6 inch TFT color LCD, Auto/manual provisioning system, GUI Interface, Address Book, Remote software upgrade (via TFTP/HTTP) for deployed devices including behind firewall/NAT
Provisioning	Support automated NAT traversal without manual manipulation of firewall/NAT Support remote automated and secure provisioning and software upgrade through firewall/NAT to enable “zero configuration” and “plug-and-dial” for end users. Support remote device monitoring and events reporting using Syslog Support device configuration via LCD, Web browser or central secure configuration file Support NAT traversal using IETF STUN and Symmetric RTP Manual or dynamic host configuration protocol (DHCP) network setup
Video Features	Powerful video DSP with advanced adaptive jitter control and packet loss concealment technology to ensure superb audio and video quality Support H.263/H.263+ (for legacy compatible) and H.264 (baseline) real-time video codec (at CIF or QVGA resolution and up to 30 frames/second) to ensure highest quality video delivery at 32kbps -- 1Mbps bandwidth level (bit rate/frame rate configurable) High quality 5.6-inch TFT color LCD (allowing 2-dimensional view angle adjustment including 180 degrees vertical rotation and nearly 300 degrees horizontal rotation) Advanced VGA resolution CMOS camera sensor (view angle adjustable) Anti-flickering, auto focus and auto exposure, zoom, PIP (Picture-in-Picture), audio mute and camera block (for privacy), call log, video phone book. Configurable screen-saver pictures, still picture capture/store (VGA resolution), visual voice message indicator Intuitive graphic user interface enabled by 5 navigation buttons
Audio Features	Full-duplex hands-free speakerphone, Advanced Digital Signal Processing (DSP) Support for G.723.1, G.729A/B, G.711 μ A (PCMU/PCMA), G.726 with dynamic negotiation of codec and packet time In-band and out-of-band DTMF (In Audio, RFC2833, SIP INFO) Silence Suppression, VAD (voice activity detection), CNG (comfort noise generation), AGC (automatic gain control), Packet delay & loss concealment Acoustic Echo Cancellation (AEC) with Acoustic Gain Control (AGC) for speakerphone mode, Support side tone, Adaptive jitter buffer control (patent-pending)
Call Handling Features	Call hold, call transfer (attended/blind), Do-Not-Disturb(DND), call forward (no answer, busy, unconditional), mute, caller ID/name display or block, call waiting, call waiting

	caller ID, 3-way conferencing, redial, dial plans, off-hook auto dial, auto answer, early dial, speed dial , call log, and volume control, Visual voice mail indicator, audio mute & camera block (for privacy), downloadable custom ring-tones
Caller ID (Privacy)	Support for anonymous call using privacy header
Firmware Upgrades	Support for Authenticating configuration file before accepting changes; Support firmware upgrade via TFTP or HTTP, Allow user to specify different URL for configuration file and firmware files
Advanced Server Features	Support DNS SRV Look up and SIP Server Fail Over, Visual message waiting indication, Support customizable idle screensaver
Security	DIGEST authentication and encryption using MD5 and MD5-sess Secure signaling (SIP over TLS, pending) and secure voice/video communication (SRTP).

USING GXV300X IP VIDEO PHONE





GETTING FAMILIAR WITH LCD

FIGURE 2: GXV LCD SCREEN

The LCD display disappears when the screensaver is on. If you do not want the LCD display, you can turn it off.

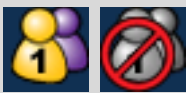

TABLE 6: LCD ICON DEFINITIONS

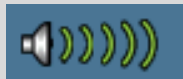
Icon	LCD Icon Definitions
	Connectivity Status / SIP Proxy/Server Icon: Color – connected to SIP Server/IP address received Gray – SIP Proxy/Server not registered
	Phone Status Icon: OFF when the handset is on-hook ON when the handset is off-hook
	Audio Mute: ON when audio mute is enabled
	DND: ON when DND is enabled
	Speaker Phone Status Icon: FLASH when phone rings or a call is pending OFF when the speakerphone is off ON when the speakerphone is on
	Handset, Speakerphone and Ring Volume Icon: Each icon appears next to the volume icon To adjust volume, use the up/down arrow button





	Real-time Clock: Synchronized to Internet time server (Internet required) Time zone configurable via web browser AM/PM indicator
	Missed Call Icon: Icon appears when you miss a call Number indicates how many missed calls
	Video Mute: ON when video is disabled
	Voice/Video Message: ON when there is unheard message
	Forward: ON when call forwarding is enabled

FIGURE 3: GETTING FAMILIAR WITH KEYPAD

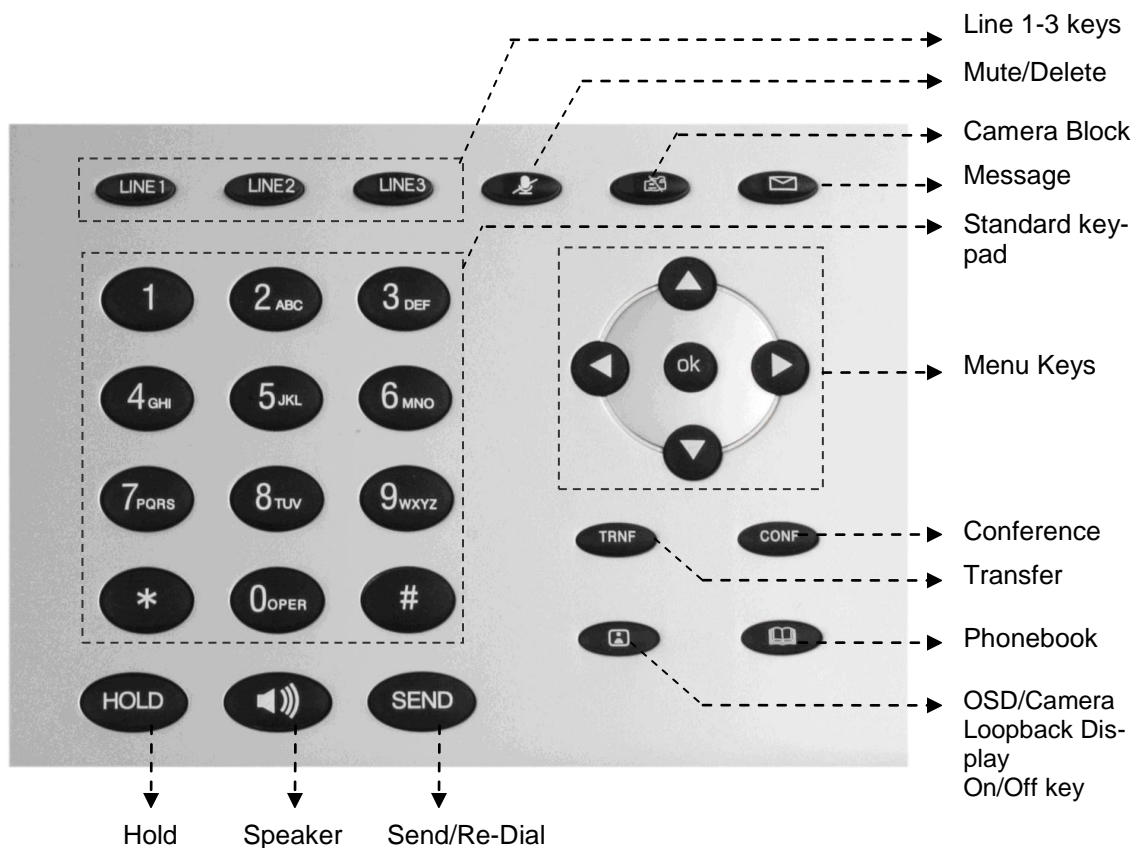

Table 7: GXV Button Definitions

Key Button	Key Button Definitions
LINE1-LINE3	3 Line keys with LED, can be configured to different SIP profiles or providers
UP ↑	Use button to select next “Menu Item” when phone is in keypad configuration mode; Or increase handset/speakerphone volume when phone is ACTIVE; Or increase ring volume when phone is in IDLE mode
DOWN ↓	Use button to select previous “Menu Item” when phone is in keypad configure mode; Or decrease handset/speakerphone volume when phone is ACTIVE; Or decrease ring volume when is in IDLE mode
LEFT ←	Shift cursor to left
RIGHT →	Shift cursor to right. Also function as shortcut to bring up Call History when phone is in idle state.
OK	Enter Keypad Configuration “MENU” mode when phone is in IDLE mode. Use as ENTER key when in Keypad Configuration.
TRNF	TRANSFER key: Transfer an ACTIVE call to another number
CONF	Press CONF button to connect Calling/Called party into conference
 MESSAGE	Enter to retrieve (video) voice mails or other messages
 CAMERA BLOCK	Enable/Disable Camera for privacy. Block camera to make call without video. When button is activated, an red icon will flash on the LCD and the phone functions as a normal IP phone
 MUTE/DEL	Enable/Disable Mute. On an active call, press button MUTE the call; When using in keypad configuration, function as DELETE key; Activate/De-activate do-not-disturb (DND) when idle; Reject an incoming call during ring stage (send caller directly to voicemail)
 CAMERA LOOPBACK DIS- PLAY and OSD ON/OFF	Enable/Disable camera local loopback display; On Screen Display (OSD), function like loop switch when pressed.
 ADDRESS BOOK	XML based Video Phone Address Book
 SPEAKER	Enable/Disable hands-free speaker phone mode
HOLD	Place ACTIVE call on hold
SEND	Press SEND to dial a new number or ReDial the last number dialed. Function as Enter key when using Mini Web Browser, combined with four arrow keys to use keypad to navigate webpage if no USB keyboard/mouse

MULTIPLE SIP ACCOUNTS AND LINES

The GXV300x can support up to 3 independent SIP accounts. Each account is capable of independent SIP server, user and NAT settings. Each of the 3 line buttons (LINE1-LINE3) is “virtually” mapped to an individual SIP account. In off-hook state, select an idle line and the name of the account (as configured in the web interface) is displayed on the LCD and a dial tone is heard. Or, press the selected line continuously until the related SIP profile showed up on the LCD.

For example: Configure the three SIP accounts as “FreeWorldDialup”, “BroadSoft” and “Asterisk PBX” respectively and ensure each is active and registered. When LINE1 is pressed, you will hear a dial tone and see “FreeWorldDialup” on the LCD display; when LINE2 is pressed, you will hear a dial tone and see “BroadSoft” on the LCD display; when LINE3 is pressed, you will hear a dial tone and see “Asterisk PBX” on the LCD display. Or press LINE1 twice you will hear dial tone and see “BroadSoft” also.

To make a call, select the line you wish to use. The LED will light up solid red. If you continue to press one LINE, it will circulate among the registered accounts.

For example: when LINE1 is pressed, the LCD displays “FreeWorldDialup”; If LINE1 is pressed twice, the LCD displays “BroadSoft” and the subsequent call will be made through SIP account 2 - BroadSoft.

Incoming calls to a specific account will attempt to use its corresponding LINE if it is not in use. When the “virtually” mapped line is in use, the GXV300x will flash the next available LINE (from left to right) in red. A line is ACTIVE when it is in use and the corresponding LED is solid red.

Handset, Speakerphone and Headset Mode

Handset can be toggled between Speaker/Headset. To switch between Handset and Speaker/Headset, press the *Hook Flash* in the handset cradle or press the SPEAKER button.

Completing Calls

There are four ways to complete a call:

1. **DIAL:** To make a phone call
 - Take Handset/SPEAKER/Headset off-hook
Or press an available LINE key (activates speakerphone).
 - The line will have a dial tone and the primary line (LINE1) LED is red.
If you wish, select another LINE key (alternative SIP account).
 - Enter the phone number.
 - press the SEND key.
2. **REDIAL:** To redial the last dialed phone number.
When redialing the phone will use the same SIP account as was used for the last call. Thus, when the third SIP account was made for the last call/call attempt, the phone will use the third account to redial.
 - Take Handset/SPEAKER/Headset off-hook or
press an available LINE key (activates speakerphone), the corresponding LED will be red.
 - Press the SEND button
3. **USE THE MENU:** Press the OK button to bring up the Main Menu. Select Phone Book and select phone number. Press OK to select and press OK again to dial. The call will dial out in *speaker-mode* with related SIP profile.

4. **USING THE CALL HISTORY:** To call the a phone number in the phone's history When using the call history, the phone will use the same SIP account as was used for the last call/call attempt. Thus, when returning a call made to the third SIP account, the phone will use the third SIP account return the call.
 - Press the MENU button to bring up the Main Menu.
 - Select Call History and then "Received Calls", "Missed Calls" or "Dialed Calls" depending on your needs
 - Select phone number using the arrow keys
 - Press OK to select
 - Press OK again to dial.

5. **USING THE PHONEBOOK:** Calling a phone in from the phone's phonebook. Each entry in the phonebook can be attached to an individual SIP account. The phone will use that SIP account to make the phone call.
 - Go to the phonebook by:
 - i. Pressing the phonebook button (bottom, left-hand side of phone), or
 - ii. Pressing the DOWN arrow key, or
 - iii. Pressing the menu button and
Selecting "Phone book" and
Press MENU
 - Select the phone number by using the arrow keys
 - Press OK so select
 - Press OK again to dial.

6. **Paging/Intercom:**

The paging/intercom function can only be used if the SERVER/PBX supports this feature and both the phones and PBX are correctly configured.

 - Take the Handset/SPEAKER/Headset off-hook,
 - Select the LINE key associated with account
 - Press OK key to display LCD: **LINEx: PAGE USING.**
 - Dial the phone number you want to Page/Intercom
 - Press SEND key.

NOTE:

- Dial-tone and dialed number display occurs after the handset is off-hook and the line key is selected.
- The phone waits 4 seconds (by default; no key entry timeout) before sending and initiating the call. Press the "SEND" button to override the 4 second delay.

Making Calls using IP Addresses

Direct IP calling allows two phones to talk to each other in an ad hoc fashion **without a SIP proxy**. VoIP calls can be made between two phones if:

- Both phones have public IP addresses, or
- Both phones are on a same LAN/VPN using private or public IP addresses, or

- Both phones can be connected through a router using public or private IP addresses (with necessary port forwarding or DMZ)

To make a direct IP call, please follow these steps:

1. Press MENU button to bring up MAIN MENU.
2. Select "Direct IP Call" using the arrow-keys.
3. Press OK to select.
4. Input the 12-digit target IP address. (Please see example below).
5. Press OK key to initiate call.

For example: If the target IP address is 192.168.1.60 and the port is 5062 (e.g. 192.168.1.60:5062), input the following: **192*168*1*60#5062** - "*" key represent "." and "#" key represent ":". Press OK to dial out.

Quick IP Call Mode

Dial an IP address under the same LAN/VPN by keying in the last octet in the IP address. This partially simulates a PBX function using the CMSA/CD without a SIP server. Static IP usage recommended.

In the "Advanced Settings" page, set the "Use Quick IP-call mode" to "YES". When #xxx# is dialed, where x is 0-9 and xxx <=255, a direct IP call to aaa.bbb.ccc.XXX is completed. "aaa.bbb.ccc" is from the local IP address *regardless* of subnet mask.

#xx or #x are also valid. The leading 0 is not required (but OK).

For example:

- 192.168.0.2 calling 192.168.0.3 -- dial #3 follow by SEND or #
- 192.168.0.2 calling 192.168.0.23 -- dial #23 follow by SEND or #
- 192.168.0.2 calling 192.168.0.123 -- dial #123 follow by SEND or #
- 192.168.0.2: dial #3 and #03 and #003 results in the same call -- call 192.168.0.3

NOTE: If you have a SIP Server configured (not recommended for IP calling), a Direct IP-IP still works. If you are using STUN, the Direct IP-IP call will also use STUN. Configure the "Use Random Port" to "NO" when completing Direct IP calls.

MAKING PHONE CALLS

Receiving Calls

1. **Incoming single call:** Phone rings with selected ring-tone. The corresponding account LINE flashes red. Answer call by taking Handset/SPEAKER/Headset off hook or pressing SPEAKER.
2. **Incoming multiple calls:** Call Waiting tone audible. Next available lines will flash red .
3. **Paging/Intercom Enabled:** Phone beeps once and automatically establishes the call via SPEAKER. (PBX or Server must support this feature first)

Call Waiting/ Call Hold

1. **Hold:** Place a call on 'hold' by pressing the "HOLD" button.
2. **Resume:** Resume call by pressing the corresponding blinking LINE key.
3. **Multiple Calls:** Automatically place ACTIVE call on 'HOLD' by selecting another available LINE key to place or receive another call. Call Waiting tone audible when line is in use and there is a call waiting to be answered.

Call Transfer

GXV300x supports both blind and attended (or supervised) transfer:

1. **Blind Transfer:** Press "TRNF" button, then dial the number and press the "SEND" button to complete transfer of an active call.
2. **Attended (or Supervised) Transfer:** Press "Line x" button to make a call and automatically place the ACTIVE LINE on HOLD. Once the call is established, press "TRNF" key then the key with blinking line to transfer the call and hang up.

NOTE:

- To transfer calls across SIP domains, SIP service providers must support transfer across SIP domains. Blind transfer will usually use the primary account SIP profile.
- If pressed wrong number and want to cancel the transfer, just press the "TRNF" again to cancel the transfer. Or press HOLD key to hold the line and redo again.

3-Way Conferencing

GXV-3000 supports 3-way conferencing.

1. **Initiate a Conference Call:** Place first call on hold by press LINE key to call second party and establish the call, press the CONF button then press the line on hold (blinking), bring three parties together.
2. **Toggle Video Conference:** Once the 3-way conference is established, press the CONF key to toggle between two video users for video.

3. **Cancel Conference:** If after pressing the “CONF” button, a user decides not to conference anyone, press CONF again will cancel the operation.
4. **End Conference:** To end a conference, one way is to press HOLD, this breaks the conference and places both parties on hold, user can now speak to individual party by selecting the corresponding blinking LINE. Another way is simply hand up and terminate the call.

Voice Messages (Message Waiting Indicator)

The blinking red MWI (Message Waiting Indicator) indicates a message is waiting. Press the MSG button to retrieve the message (if configured). An IVR will prompt the user through the process of message retrieval. Press a specific LINE to retrieve messages for a specific line account.

NOTE:

- Each line has a separate voicemail account. Each account requires a voicemail portal number to be configured in the “Voice Mail User ID” field.
- To check which line account has a message:
 1. Press the message button (this always checks the primary account)
 2. Check each line for stutter tone
 3. Or, check missed calls using the menu key.

Mute/Delete

1. To enable/disable mute during a call, press “MUTE/DEL” button. The red Mute/Delete icon (muted microphone) will flash on the LCD. Press the “MUTE/DEL” button again to resume audio.
2. To delete wrong entries while using the keypad “MENU” operation by moving cursor (use the arrows to move cursor) before the entry. Press “MUTE/DEL” to delete the digit or letter.

NOTE: Pressing MUTE button for an incoming call will reject the call. MUTE button also functions as delete key when user wishes to delete the last entered digit.

Do Not Disturb

1. Press the “Mute/Delete” button if you do not want to take a call when in ringing stage. This will send the caller directly to voicemail (if user has a voicemail) or reject the incoming call.
2. Press the “Mute/Delete” button when phone is idle to set the phone to DND (Do not Disturb) mode (an icon will flash on the screen). The phone will not ring and send caller directly to voicemail if user has one.

Camera Block

To disable/enable video during a call, press the CAMERA BLOCK button. The video is disabled but the audio remains enabled. The flashing red blocked camera icon in the LCD indicates the call is not in video mode and the camera is blocked for purpose like privacy.

Camera Local Loopback Display and OSD ON/OFF

Enable/Disable camera local loopback display and OSD (On Screen Display). This key functioning in loop switch when pressed continuously, the camera local loop back, OSD display, PIP, PIP swap will appear or happen on the LCD screen continuously in a loop mode.

OSD Display Explanation:

- PCMU/H.264: Audio / Video codec used in the call, this shows audio is using G.711 μ law (PCMU) and video is using H.264
- 86K/15F: This shows RECEIVING bandwidth used in the call (OSD always shows other side bandwidth used). Video bandwidth received is 86K @ 15 frames per second. The top left and right time stamp show current time and call duration.

Making/Receiving Calls via PSTN (only applicable on GXV3005)

The GXV3005 is based on the same high performance feature set as the GXV3000. The additional FXO/PSTN port supports calling over and between two networks (IP and PSTN network) from a single phone and offers both a layer of security and back up for IP video phone communication by providing the option of a PSTN life line.

Pressing LINEx button few times until "LINEx: Dial USING PSTN" shown on LCD to make calls via PSTN. If the call is going through the PSTN line, then the video feature will not be available and the call will only contain audio.

Making/Receiving Calls Using Analog Phone (only applicable on GXV3006)

The GXV3006 is based on the same high performance feature set as the GXV3000. The additional Phone/FXS port allow making/answering call by using analog phone.

Making calls

Making call using analog phone through different lines can be done in two different ways.

- Pressing LINEx button on GXV3006 main case. Then, dial destination number on analog phone.
Or
- Dial *x* on analog phone to get second dial tone. Then, dial the destination number.
Note: "x" represents the line which will be used to make calls.
For example: Dialing *3* on analog phone will get the second dial tone. Then, dial the destination number.

Receiving calls

When receiving calls, not only GXV3006 main phone would ring but also the analog phone. Picking up the handset of analog phone will also answer the call.

After the call is answered, audio can be heard on both GXV3006 and the analog phone by picking up handset. Video can be seen on GXV3006 no matter the call is answered by GXV3006 or the analog phone.

CALL FEATURES

The GXV300x supports traditional and advanced telephony features provided the server supports them.

TABLE 8: GXV300X CALL FEATURES

Key	Call Features
*30	Block Caller ID (for all subsequent calls)
*31	Send Caller ID (for all subsequent calls)
*50	Disable Call Waiting (for all subsequent calls)
*51	Enable Call Waiting (for all subsequent calls)
*67	Block Caller ID (per call)
*82	Send Caller ID (per call)
*70	Disable Call Waiting (per Call)
*71	Enable Call Waiting (per Call)
*72	Unconditional Call Forward Dial “*72”, wait for a dial tone. Dial the forwarding number followed by “#”, wait for dial tone confirmation. LCD will display “Call FWD Activated”.
*73	Cancel Unconditional Call Forward: dial “*73” and get the dial tone to confirm the operation, then hang up. “Call FWD Activated” will disappear.
*90	Busy Call Forward Dial “*90”, wait for a dial tone. Dial the forwarding number followed by “#”. Wait for a dial tone confirmation. Hang up.
*91	Cancel Busy Call Forward: dial “*91”. Wait for dial tone confirmation. Hang up.
*92	Delayed Call Forward Dial “*92” for a dial tone. Dial the forwarding number followed by “#”. Wait for a dial tone confirmation. Hang up. LCD will display “Call FWD Activated”.
*93	Cancel Delayed Call Forward Dial “*93”, wait for dial tone confirmation, then hang up.

CONFIGURATION GUIDE

The GXV300x can be configured in two ways. Firstly, using the Key Pad Configuration Menu on the phone; secondly, through embedded web-configuration menu.

CONFIGURE OPERATION WITH KEYPAD

- To enter the MENU, press the OK button.
- Navigate the menu by using the arrow keys: up/down and left/right.
- Confirm a menu selection by pressing the OK button
- Delete an entry by moving the cursor before it then pressing the MUTE/DEL button.

The phone automatically exits keypad MENU mode when there is an incoming call, the phone is off-hook or the MENU mode if left idle for 20 seconds.

FIGURE 4: CONFIGURE MENU OPTIONS

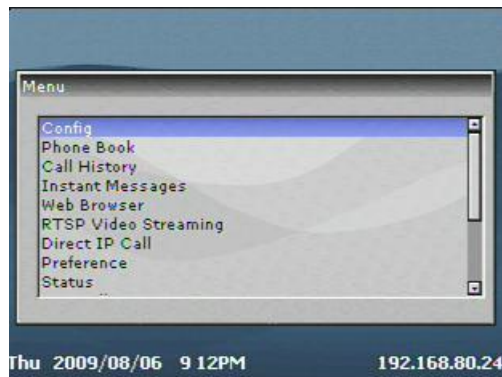

FIGURE 5: FLOW CHART OF KEY PAD CONFIGURATION MENU

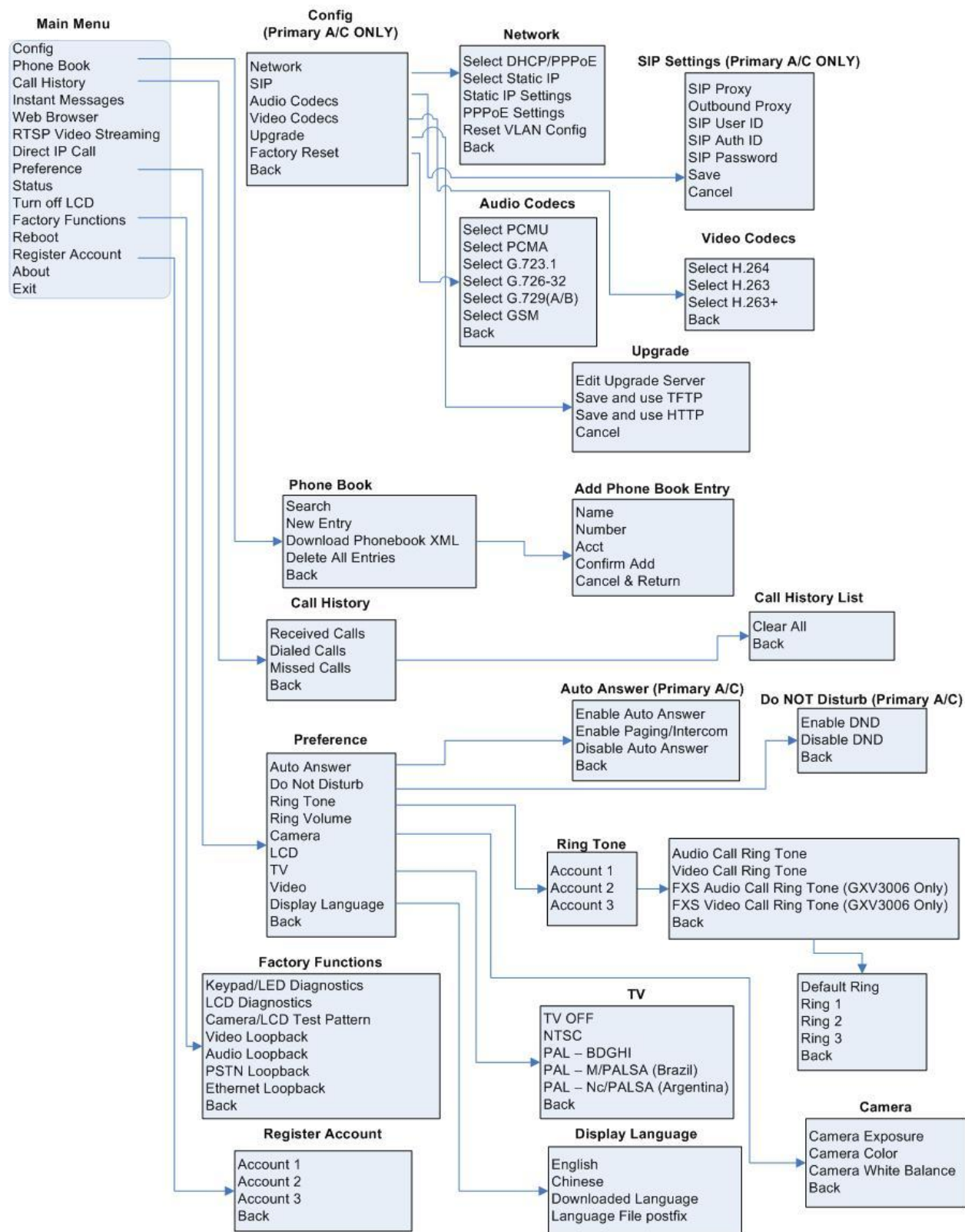

TABLE 9: KEY PAD CONFIGURATION MENU

<p>Config</p>	<p>Press <i>Menu</i> button to display the configuration selections:</p> <ul style="list-style-type: none"> • Network. To enable/disable DHCP. To setup IP-address, Net mask and Gateway address • SIP To change SIP-server settings for primary account. • Audio • Video Codecs • Upgrade In this menu setting regarding the firmware server and config server can be changed. It also enables the user to make the phone attempt to download new firmware. • Factory Reset Key in the physical/MAC address on back of the phone. Press <i>Menu</i> button to reset FACTORY DEFAULT setting. Do not use Factory Reset unless you want to restore factory settings Press '←' to return the main menu.
<p>Phone Book Call History Web Browser RTSP Video Streaming Direct IP Call</p>	<p>Displays the phonebook</p> <p>Displays histories of incoming, dialed and missed calls.</p> <p>Displays the IP-call options menu</p>
<p>Preference</p>	<p>Press <i>Menu</i> button to enter this sub menu including</p> <ul style="list-style-type: none"> • Auto Answer • “Do NOT Disturb” DND (Do NOT Disturb) function could be turned on or off in the “DO NOT Disturb” menu. • Ring Tone Choose different ring tones in the “Ring Tone” menu. • Ring Volume Press <i>Menu</i> button to hear the selected ring volume, press '←' or '→' to hear and adjust the ring tone volume. • Camera • LCD • TV • Video • Display Language Press <i>Menu</i> button to choose the menu item. Press '←' to return to the main menu.
<p>Status Turn Off LCD</p>	<p>Displays the network status, account statuses, software version and MAC-address of the phone.</p> <p>Press <i>Menu</i> button to turn off LCD</p>
<p>Factory Functions</p>	<p>Press <i>Menu</i> to display the factory function items including</p>

	<ul style="list-style-type: none"> • Keypad/LED Diagnostics All LEDs will light up Press any key on the keypad, to display the button name in the LCD. Lift and put back the handset or press <i>Menu</i> button to exit the diagnostic mode. • LCD Diagnostics • Camera/LCD Test Pattern • Video Loopback • Audio Loopback Speak into the handset. If you hear your voice in the handset, your audio works fine. Press <i>Menu</i> button to exit the mode. • PSTN Loopback • Ethernet Loopback Connect a cross Ethernet cable from your “PC” port, and the “LAN” port. The test result is displayed on the screen. Use this feature to diagnose the state of health of the RJ45 jacks. Press <i>Menu</i> button to exit the diagnostic mode. Note: Running the Ethernet Loopback mode with a normal connection will cause IP loss. Press ‘←’ to return to the main menu.
Reboot	Press <i>Menu</i> button to reboot the device
Register Account	Choose Account to force the phone sends out registration request
About	
Exit	Exit from this menu.

CONFIGURATION WITH WEB BROWSER

The GXV300x embedded Web server responds to HTTP/HTTPS GET/POST requests. Embedded HTML pages allow a user to configure the IP phone through a Web browser such as Microsoft’s IE or Mozilla Firefox.

Access the Web Configuration Pages

The GXV IP Phone Web Configuration Pages URL: <http://Phone-IP-Address> where the *Phone-IP-Address* is the IP address of the phone displayed on the LCD screen.

To access the phone’s Web Configuration Menu

- Connect the computer to the same network as the phone¹
- Make sure the phone is turned on and shows its IP-address
- Start a Web-browser on your computer
- Enter the phone’s IP-address in the address bar of the browser²
- Enter the administrator’s password to access the Web Configuration Menu³

¹ The Web-enabled computer has to be connected to the same sub-network as the phone. This can easily be done by connecting the computer to the same hub or switch as the phone is connected to. In absence of a hub/switch (or free ports on the hub/switch), please connect the computer directly to the phone using the PC-port on the phone.

² If the phone is properly connected to a working Internet connection, the phone will display its IP address. This address has the format: xxx.xxx.xxx.xxx, where xxx stands for a number from 0-255. You will need this number to access the Web Configuration Menu. **e.g.** if the phone shows 192.168.0.60, please use “*http://192.168.0.60*” in the address bar your browser.

³ The default administrator password is “**admin**”; the default end-user password is “**123**”.

NOTE: When changing any settings, always SUBMIT them by pressing the button on the bottom of the page. Reboot the phone to have the changes take effect. If, after having submitted some changes, more settings have to be changed, press the menu option needed.

Definitions

This section will describe the options in the Web configuration user interface. As mentioned, a user can log in as an administrator or end-user.

Functions available for the end-user are:

- **Status:** Displays the network status, account statuses, software version and MAC-address of the phone
- **Basic:** Basic preferences such as date and time settings, multi-purpose keys and LCD settings can be set here.

Additional functions available to administrators are:

- **Advanced Settings:** To set advanced network settings, codec settings.
- **Account:** To configure each of the SIP accounts
- **FXO Settings** :This is only applicable on GXV3005
- **FXS Settings** :This is only applicable on GXV3006

TABLE 10: STATUS PAGE DEFINITIONS

Hardware Revision	Hardware version number: Main Board, Interface Board
Part Number	This field contains the product part number
MAC Address	The device ID, in HEX format. This is a very important ID for ISP troubleshooting.
IP Address	This field shows IP address of GXV300x
Product Model	This field contains the product model information.
Software Version	<ul style="list-style-type: none">• Program: This is the main firmware release number, always used for identify the whole software (or firmware) system of the phone.• Loader: Driver loader code version number.• Boot: Booting code version number
System Up Time	This field shows system up time since the last reboot.

Registered	This field indicates whether the accounts are registered to the related SIP server(s). GXVx3000 can support up to three different SIP profiles.
PPPoE Link Up	This field shows whether the PPPoE connection is up if connected directly to DSL modem.
NAT / NAT Mapped IP	This field shows what kind NAT router the GXV300x is connected to. It is based on the resolve result of STUN Server used. STUN will not work if it is Symmetric NAT. Outbound Proxy (or Session Border Controller) has to be used to resolve this situation.
Total Inbound Calls	Total number of calls received since last reboot.
Total Outbound Calls	Total number of calls made since last reboot.
Total Missed Calls	Total numbers of calls missed since last reboot.
Total SIP Message Sent	Total number of SIP messages sent out since last reboot.
Total SIP Message Received	Total number of SIP messages received since last reboot.
Total RTP Packet Sent	Total number of RTP packets sent since last reboot.
Total RTP Packet Received	Total number of RTP packets received since last reboot.
Total RTP Packet Loss	Total number of RTP packets lost since last reboot.

END USER CONFIGURATION

Once this HTTP request is entered and sent from a Web browser, the GXV300x will respond with a login screen. There are two default passwords for the login page:

User Level:	Password:	Webpages allowed:
End User Level	123	Only Status and Basic Settings
Administrator Level	admin	Browse/edit ALL pages

After login, the next configuration page is the Basic Configuration page.

TABLE 11: BASIC CONFIGURATION DEFINITIONS

Web Access	Select HTTP or secure HTTPS protocol for Web Access
Web Port	By default, HTTP uses port 80 and HTTPS uses port 443. This field is for customizable web port.
End User Password	This contains the password to access user lever Web Configuration Pages. This field is <u>case sensitive</u> with a maximum length of 25 characters.

IP Address	<p>The GXV300x operates in two modes:</p> <ul style="list-style-type: none"> • DHCP mode: all the field values for the Static IP mode are not used (even though they are still saved in the Flash memory.) The GXV300x acquires its IP address from the first DHCP server it discovers on its LAN. The DHCP option is reserved for NAT router mode (currently NOT implemented). • To use the PPPoE feature, set the PPPoE account settings. The GXV300x establishes a PPPoE session if any of the PPPoE fields is set. • Preferred DNS Server: If configured and enabled, all the DNS query will be sent to this server instead of other DNS servers from network. • Static IP mode: configure all of the following fields: IP address, Subnet Mask, Default Router IP address, DNS Server 1 (primary), DNS Server 2 (secondary).
Time Zone	<p>This parameter controls the date/time display according to the specified time zone. The “Allow DHCP Option 2 to override Time Zone setting” give DHCP server to overwrite default NTP time server if user has own NTP server. Default is No.</p>
Daylight Savings Time	<p>This parameter controls time displayed in daylight savings time. If set to “Yes”, then the displayed time will be 1 hour ahead of normal time.</p> <p>The “Optional Rule” is configured to automatically adjust the Daylight Savings Time (DST) based on the rule set in this field.</p> <p>Rule Syntax:</p> <ul style="list-style-type: none"> • start-time; end-time; saving • Both start-time and end-time have the same syntax: month,day,weekday,hour,minute <ul style="list-style-type: none"> ○ month: 1,2,3,...,12 (for Jan, Feb, ..., Dec) ○ day: [+ -]1,2,3,...,31 ○ weekday: 1, 2, 3, ..., 7 (for Mon, Tue, ..., Sun), or 0 which means the daylight saving rule is not based on week days but based on the day of the month. ○ hour: hour (0-23), minute: minute (0-59) <p>If “weekday” is 0, it means the date to start or end daylight saving is at exactly the given date. In that case, the “day” value must not be negative. If “weekday” is not zero and “day” is positive, then the daylight saving starts on the first “day” the iteration of the weekday (e.g.: 1st Sunday, 3rd Tuesday etc). If “weekday” is not zero and “day” is negative, then the daylight saving starts on the last “day” the iteration of the weekday (e.g.: last Sunday, 3rd last Tuesday etc).</p> <p>The saving is in the unit of minutes. The saving time may also be preceded by a negative (-) sign if subtraction is desired instead of addition.</p> <p>The default value is set for US, the “Automatic Daylight Saving Time Rule” shall be set to “3,2,7,2,0;11,1,7,2,0;60”</p> <p><u>Examples</u> US/Canada where daylight saving time is applicable: 03,02,7,02,00;11,1,7,02,00;60 This means the daylight saving time starts from the second Sunday of March at 2AM and ends the first Sunday of November at 2AM. The saving is 60 minutes.</p>
Time Display Format	<p>LCD time display in 12 hour or 24 hour format</p>
Date Display Format	<p>Choose one of the following formats:</p> <ul style="list-style-type: none"> • Year-Month-Day • Month-Day-Year • Day-Month-Year
Display Clock instead of Date	<p>Default is No. Display the clock instead of Date. If set to “Yes”, it will show the clock in the LCD instead of date.</p>

Disable SIP User Display	Default is No. If enabled, SIP User ID will not show on the LCD
Disable IP Address Display	Default is No. If enabled, the IP address of the phone will not show on the LCD
LCD Screen Saver Start Interval	Default value is 60 seconds, 0 means turn off this feature. After 60 seconds the Screen Saver will start. The Screen saver file stored in flash is limited to 20 images or 320kb. Change screen saver in the same way as customized ring tone.
LCD Screen Saver Refresh Interval	Default is 10. This parameter controls the picture changing speed showed on the LCD.
LCD Auto Power Off Interval	Default value is 300 seconds. 0 means LCD is always ON After 300 seconds of idle time, the LCD will automatically Power Off.
LCD Brightness Brightness	Default value is 128
LCD Contrast	Default value is 128
LCD Chroma Saturation	Default value is 128
LCD Text Color	Change the LCD font text color, adjust via selected numbers. Default is 255
LCD Background Color	Select desired LCD Background color from the drop down box. Initial all is 0, can be adjusted to the color designed
OSD Text Color	Select desired OSD (On Screen Display) Text color from drop down box. Default is white. The color can distinguish OSD from video background
PIP Position	Local Mirror Images showed via Picture in Picture positions in the LCD. Default is Top Left.
Starting Video OSD/PIP Mode	Default value is OSD On, PIP On
Camera Zoom Mode	Select desired camera zoom mode (Tele, optical, digital). Can adjust local video zoom either in mirror mode or during the call (on the fly) by pressing the Left or Right Arrow Key
Camera Exposure	Select desired Camera Exposure mode based on surroundings. Default to Auto
Camera Color Mode	Select desired Camera Color Mode (Color or Monochromatic). Default to Color Mode
Camera White Balance	Select desired Camera White Balance to be automatic or Fixed. Default to Auto
Camera Lens Correction	Correct Camera Lens noise. Default is Yes. Recommend set to YES to reduce camera lens noise and improve video quality.
TV Output	Select desired TV Output type (PAL or NTSC).

ADVANCED USER CONFIGURATION

The Advanced User configuration includes not only the end user configuration, but also advanced configuration such as SIP configuration, Codec selection, NAT Traversal Setting and other miscellaneous configuration.

Login to the Advanced User Configuration page following the same directions as in Basic Configuration. The factory default password for Advanced User is “admin”. User may change the password. The password is case sensitive with a maximum length of 25 characters.

TABLE 12: ADVANCED SETTINGS CONFIGURATION PAGE DEFINITIONS

Admin Password	Administrator password. Only the administrator can configure the “Advanced Settings” page and “Account x” pages. Password field is purposely blank for security reasons after clicking update and saved. The maximum password length is 25 characters.
G723 rate	G.723 audio codec encoding rate, either 6.3kbps or 5.3kbps, check with ITSP or Server/Proxy.
Silence Suppression	This controls the silence suppression/VAD feature of the audio codec G.723 and G.729. If set to “Yes”, when silence is detected, a small quantity of VAD packets (instead of audio packets) will be sent during the period of no talking. If set to “No”, this feature is disabled.
Voice Frames per TX	This field contains the number of voice frames to be transmitted in a single Ethernet packet (be advised the limit is based on the maximum size of Ethernet packet which is 1500 byte or 12kbps). When setting this value, be aware the requested packet time (ptime, used in SDP message) is a result of configuring this parameter. This parameter is associated with the <u>first</u> codec in the above codec Preference List or the actual used payload type negotiated between the 2 conversation parties at run time. <i>e.g.</i> , if the first codec is configured as G.723 and the “Voice Frames per TX” is set to 2, then the “ptime” value in the SDP message of an INVITE request will be <u>60ms</u> because each G.723 voice frame contains 30ms of audio. Similarly, if this field is set to 2 and the first codec is G.729 or G.711 or G.726, then the “ptime” value in the SDP message of an INVITE request will be <u>20ms</u> . If the configured voice frames per TX exceeds the maximum allowed value, the IP phone will use and save the maximum allowed value for the corresponding <u>first codec</u> choice. The maximum value for PCM is 10 (x10ms) frames; for G.726, it is 20 (x10ms) frames; for G.723, it is 32 (x30ms) frames; for G.729/G.728, 64 (x10ms) and 64 (x2.5ms) frames respectively. Please be careful when editing these parameters. Adjusting these parameters will also change the jitter buffer. The GXV300x has a patent jitter buffer handling algorithm. Grandstream recommends using the default settings and not adjusting these parameters. Incorrect settings will affect the voice quality.
Video Frame Rate	Default value is 15 frames/second. The video frame rate is adjustable based on network conditions. Increasing the frame rate will increase the amount of data significantly therefore consuming more bandwidth. Lack of bandwidth the video will get impaired due to packet loss.
Video bit rate (kbps)	Default value is 128 kbps. The video bit rate is adjustable based on network environment. Increasing video bit rate may improve video quality if bandwidth allows. Otherwise the video quality will get impaired due to packet loss. Video downloading bit rate can also be adjusted after video conversation is established. - Use MWI button  to toggle between VOLUME, BIT RATE, and Tone Remapping Filter mode. - After choosing the feature, use UP and DOWN arrow button to adjust. By pressing the UP and DOWN button, GXV300X sends out SIP INFO to tell remote party increase/decrease its uploading rate.

Video Packet Size	Default value is 1400, range from 100 to 1400. Recommended using 600~800 if you have Outbound Proxy or Media Gateway.
Video Rate Control	Frame or TMN8. Default is Frame. TMN8 is good for bandwidth bigger than 384kbps
Video Frame Skipping	Skipping the bad video frame received Default is No.
Sharpening Filter	Sharpening filter for incoming video. Default value is 5
Brightening Filter	Brightening filter for incoming video. Default value is 5
Tone Remapping Filter	Default value is 32. It can be used to improve video quality under low light conditions by equalizing (remapping) colors/tones. Tone Remapping Filter can also be adjusted after video conversation is established. - Use MWI button  to toggle between VOLUME, BIT RATE, and Tone Remapping Filter mode. - After choosing the feature, use UP and DOWN arrow to adjust.
Packetization-mode	Default is 0 .
Enable Video Surveillance	Default is No . If configured to YES, the video phone can be turned to a video surveillance camera after the phone rebooted.
Surveillance RTSP port	This is the port for the video surveillance camera data stream. Default is 554.
Streaming RTSP Server	This is for the URI of the streaming RTSP server. GXV300x can also be a remote surveillance monitor for another GXV300x phone used as surveillance camera or other supported IP Camera or video source. For such application, both devices (Server and Monitor) have to be in the same LAN or VPN.
Streaming RTSP User ID	The user ID used to connect to RTSP server. To act as remote surveillance monitor, the GXV300x has to give the RTSP server authorized User ID in order to fetch the RTSP streaming packets.
Streaming RTSP Password	The password used to connect to RTSP server. To act as remote surveillance monitor, the GXV300x has to give the server authorized Password to match the credentials in order to fetch the RTSP streaming packets.
Layer 3 QoS	This field defines the layer 3 QoS parameter. It is the value used for IP Precedence or Diff-Serv or MPLS. Default value is 0.
Layer 2 QoS	This contains the value used for layer 2 VLAN tag (802.1q and 802.1p). Default setting is blank.
No Key Entry Timeout	Default is 4 seconds. User can press SEND key (or # key if configured) to overwrite the 4 seconds value to speedup dialing
Use # as Dial Key	This parameter allows users to configure the “#” key as the “Send” (or “Dial”) key. If set to “Yes”, the “#” key will immediately send the call. In this case, this key is essentially equivalent to the “(Re)Dial” key. If set to “No”, the “#” key is included as part of the dial string.

Local RTP port	This parameter defines the local RTP-RTCP port pair used to listen and transmit. It is the base RTP port for channel 0. When configured, for audio, channel 0 will use this port _value for RTP and the port_value+1 for its RTCP; channel 1 will use port_value+4 for RTP and port_value+5 for its RTCP. For video, channel 0 will use port_value+2 for RTP and port_value+3 for its RTCP; channel 1 will use port_value+6 for RTP and port_value+7 for RTCP. The default value is 5004
Use Random Port	This parameter, when set to “Yes”, will force random generation of both the local SIP and RTP ports. This is usually necessary when multiple GXV300xs are behind the same full cone NAT. Default is No. (This parameter should be set to NO before Direct IP Call will work)
Keep-alive interval	This parameter specifies how often the GXV300x sends a blank UDP packet to the SIP server in order to keep the “pin hole” on the NAT router to open. Default is 20 seconds.
Use NAT IP	NAT IP address used in SIP/SDP message. Default is blank. Use ONLY if ITSP requires.
STUN Server	IP address or Domain name of the STUN server. STUN resolution result will display in the STATUS page of the Web UI. Only non-symmetric NAT routers work with STUN.
Firmware Upgrade and Provisioning	This radio button will enable GXV300x to download firmware or configuration file through either HTTP or TFTP (local preferred) server. This is mutual exclusive choice.
Via TFTP Server	This is the IP address of the configured TFTP server. If selected and it is non-zero or not blank, the GXV300x will attempt to retrieve a new configuration file or new firmware from the specified TFTP server at boot time. It will make up to 3 attempts before timeout and then it will start the boot process using the existing code image in the Flash memory. If a TFTP server is configured and a new code image is retrieved, the new downloaded image will be verified and then saved into the Flash. Note: Grandstream strongly recommends that the user upgrade firmware locally in a LAN environment if using TFTP to upgrade. Please do NOT interrupt the TFTP upgrade process (especially the power supply) as this might damage the device.
Via HTTP Server	The HTTP server URL used for firmware upgrade and configuration. For example, http://provisioning.mycompany.com:6688/Grandstream/1.2.2.5 Here “:6688” is the specific TCP port that the HTTP server is using; it can be omitted if using default port 80. Please do not interrupt power when doing firmware upgrade. Note: If Auto Upgrade is set to No , GXV300x will only perform HTTP download once at boot up.
Firmware Server Path	This is the server path for Firmware server. It can be different with the Configuration server which used for provisioning
Config Server Path	This is the server path for provisioning, it can be different with firmware server.
Firmware File Prefix/Postfix	For ITSP to lock up firmware. If configured, only firmware matched with the encrypted Prefix and/or Postfix will get download and flashed into the phone.
Config File Prefix/Postfix	For ITSP to lock up configuration. If configured, only configuration file matched with the encrypted Prefix and/or Postfix will get download and flashed into the phone.
Allow DHCP Option 66 to override server	Default is Yes. If DHCP option 66 turned ON in LAN, the TFTP server can be redirected. Please be very careful to this as the redirection could brick the phone if happened during firmware upgrade.

Automatic Upgrade	<p>This function is used by ITSP. End user should NOT touch these parameters.</p> <p>Default is No. Choose “Yes” to enable automatic HTTP upgrade and provisioning. In “Check for upgrade every” field, enter the number of minutes to check the HTTP server for firmware upgrade or configuration changes. When set to “No”, the phone will only perform HTTP upgrade and configuration check once at boot up.</p> <p>Some other selections can be used to fine tune this process, it is self explainable.</p>
Authenticate Conf File	<p>Authenticate configuration file before acceptance.</p> <p>Default is No.</p>
Screen Saver Download	<p>This is the path for screen saver image downloading. It may or may not be the same path as the firmware or configuration server. User can adjust based on own network environment.</p>
Phonebook XML Download	<p>This is the path for XML based phonebook to be downloaded into the phone. User can use TFTP or HTTP to download the phonebook. User can also select whether to overwrite the manually inputted phonebook records in the flash.</p>
Network Screen Saver	<p>Enable Network Screen Saver.</p> <p>User needs to enter a HTTP URL to download screen saver image from Internet.</p>
Weather Forecast	<p>Enable weather forecast to be displayed on LCD. User needs to enter a HTTP URL to download the weather forecast that complies to the phone’s weather XML schema.</p>
Headline News	<p>Enable RSS 2.0 feed to be displayed on LCD.</p>
Offhook Auto Dial	<p>To configure a User ID/extension to dial automatically when the phone is taken offhook.</p>
DTMF Payload Type	<p>This parameter sets the payload type for DTMF using RFC2833. Default is 101.</p>
Syslog Server	<p>The IP address or URL of System log server.</p>
Syslog Level	<p>Select to report the log level. Default is NONE. The level is one of DEBUG, INFO, WARNING or ERROR. Syslog messages are sent based on the following events:</p> <ul style="list-style-type: none"> • product model/version on boot up (INFO level) • NAT related info (INFO level) • sent or received SIP message (DEBUG level) • SIP message summary (INFO level) • inbound and outbound calls (INFO level) • registration status change (INFO level) • negotiated codec (INFO level) • Ethernet link up (INFO level) • SLIC chip exception (WARNING and ERROR levels) • memory exception (ERROR level) <p>The Syslog uses USER facility. In addition to standard Syslog payload, it contains the following components: <i>GS_LOG: [device MAC address][error code] error message</i></p> <p>For example: May 19 02:40:38 192.168.1.14 GS_LOG: [00:0b:82:00:a1:be][000]. Ethernet link is up.</p>
NTP server	<p>This parameter defines the URI or IP address of the NTP (Network Time Protocol) server. GXV300x phone get its date and time from there. User can turn on DHCP Option 42 to override the NTP server if there is one in the LAN.</p>

Distinctive Ring Tone	Select Distinctive Ring Tone 1 through 3 for a particular Caller ID specified. The GXV will ONLY use selected ring tones for particular Caller IDs. For all other calls, default system ring tone will be used. If server support Alert-Info header and standard ring tone set (like Bellcore) specified, then Caller ID must leave Blank and the ring tone will be used based on the info header from server.
System Ring Tone	System ring tone. Default is North American standard. Adjust system ring tone frequencies and cadences based on local telecom standard.
Call Progress Tones	Using these settings, users can configure ring or tone frequencies based on parameters from local telecom. By default, they are set to North American standard. Frequencies should be configured with known values to avoid uncomfortable high pitch sounds. Syntax: f1=val,f2=val[,c=on1/off1[-on2/off2[-on3/off3]]]; (Frequencies are in Hz and cadence on and off are in 10ms) ON is the period of ringing (“On time” in ‘ms’) while OFF is the period of silence. In order to set a continuous ring, OFF should be zero. Otherwise it will ring ON ms and a pause of OFF ms and then repeat the pattern. Up to three cadences are supported.
Start Browser On Boot	Start the embedded mini browser in LCD once the phone boot up. Default is No.
Enable Browser Toolbar	Turn on the toolbar of the mini browser if having USB keyboard/mouse plugged. Default is Yes.
Browser Home Page	The mini browser home page. Default is about:start.htm The mini browser using special format similar to cell phone, e.g.: http://mobile.boston.com
Disable Call-Waiting	Default is No. If set to Yes, the call waiting will be disabled.
Disable Call-Waiting Tone	Default is No. if set to Yes, the call waiting tone will be disabled.
Disable Direct IP Call	Default is No. If set to Yes, the direct IP call will be disabled and not working.
Use Quick IP-Call Mode	Make an direct IP call by dialing last octet of IP address (3 digits instead of 12 digits IP address) if phones are in the same LAN/VPN. No SIP server required and that field should be blank. Default setting is No . When set to YES , if #XXX# is dialed, where X is 0-9 and XXX <=255, phone will make direct IP call to aaa.bbb.ccc.XXX where aaa.bbb.ccc comes from the LAN/VPN IP address REGARDLESS of subnet mask. #XX or #X also valid so leading 0 is not required (but OK). See Quick IP Call Mode for details.
Allow Media Loopback	Default is No. If set to Yes and server/proxy supports this feature, phone will feed loopback information to server.
Lock keypad update	Default is No. If set to “Yes”, the configuration changes via keypad are disabled. Caution: Phone could get LOCKED if user configured this option but forgot administration password or WebUI access broken.

Display Language

User can choose another display language on LCD and the phone's web UI. Language file postfix allows the language file to have different postfixes so the phone can request a particular file. It will append an underscore "_" plus the string in the language file postfix.

The default language file name is "gxx.lpf". If the field "Language File postfix" has "NL" string in it, then the phone will request "gxx_NL.lpf" instead of "gxx.lpf."

Supported language: Catalan, Czech, Dutch, Estonian, Finnish, French, German, Italian, Polish, Portuguese, Slovak, Slovenian, Spanish, Swedish and Turkish.

How to set up Secondary Language:

1. Download the language package from <http://www.grandstream.com/firmware.html>
2. Unzip the language package
3. Open the desired language zip file
4. Copy gxx.lpf to the firmware server directory
5. Access the advanced settings of the Web GUI, modify the "Firmware Server Path" and check "Downloaded Language"
6. Update and reboot the phone

INDIVIDUAL ACCOUNT SETTINGS

The GXV300x has 3 line appearances, each with an independent SIP account. Each SIP account requires its own configuration page. Their configurations are identical.

TABLE 13: SIP ACCOUNT CONFIGURATION PAGE DEFINITIONS

Account Active	This field indicates whether the account is active. The default value for the primary account (Account 1) is Yes. The default value for the other two accounts is No.
Account Name	The name associated with each account - displayed on LCD.
SIP Server	SIP Server's IP address or Domain name provided by VoIP service provider.
Outbound Proxy	IP address or Domain name of Outbound Proxy or Session Border Controller. Used by GXV300x for firewall or NAT penetration in different network environment. If it detects symmetric NAT, STUN will not work. ONLY OBP or session border controller can provide solution for symmetric NAT.
SIP User ID	User account information provided by VoIP service provider (ITSP). It is either an actual phone number or something formatted like one.
Authenticate ID	SIP service subscriber's Authenticate ID used for authentication. It can be identical to or different from SIP User ID.
Authenticate Password	SIP service subscriber's account password for GXV300x to register to (SIP) server.
Name	SIP service subscriber's name that is used for Caller ID display.
Use DNS SRV	Default is No . If set to "Yes", phone will use "Preferred DNS SRV" (Basic Setting Page) to look up server.
User ID is Phone Number	If the GXV300x has an assigned PSTN telephone number, this field should be set to "Yes". Otherwise, set it to "No". If "Yes" is set, a "user=phone" parameter will be attached to the "From" header in SIP request to indicate the E.164 number
SIP Registration	This parameter controls whether the GXV300x needs to send REGISTER messages to the proxy/server. The default setting is "Yes".
Unregister on Reboot	Default is No . If set to "Yes", the SIP user's registration information will be cleared on reboot and "*" will be in SIP Contact header to notify the server to unbinding all.
Register Expiration	This parameter allows user to specify the time frequency (in minutes) that GXV300x refreshes its registration with the specified registrar. The default interval is 60 minutes. The maximum interval is 65,535 minutes (about 45 days).
SIP Registration Failure-Retry Wait Time	Retry registration if the process failed. Default is 20 seconds.
Local SIP port	This parameter defines the local SIP port used to listen and transmit. The default value for Account 1 is 5060. It is 5062, 5064 for Account 2 and Account 3.

NAT Traversal (STUN)	<p>This parameter defines whether the NAT traversal mechanism is activated. If activated (by choosing “Yes”) and a STUN server is also specified, then the GXV300x will behave according to the STUN client specification. Using this mode, the embedded STUN client detects what type of NAT/Firewall router used and displayed the result in Status Page.</p> <p>If the detected NAT is a Full Cone, Restricted Cone, or a Port-Restricted Cone, the GXV300x will attempt to use its mapped public IP address and port in all of its SIP and SDP messages.</p> <p>If the NAT Traversal field is set to “No, but send keep-alive” with no specified STUN server, the GXV300x will periodically (every 20 seconds or so) send a blank UDP packet (with no payload data) to the SIP server to keep the “hole” on the NAT router open.</p> <p>If the detected NAT is symmetric NAT, then STUN can NOT be used and an Outbound Proxy or Session Border Controller must be used and this field must be configured to “NO”.</p>
Keep-Alive Using SIP OPTIONS	Default is No
Subscribe for MWI	Default is No . When set to “Yes” a SUBSCRIBE for Message Waiting Indication will be sent periodically. GXV300x supports both synchronized and non-synchronized MWI.
Proxy-Require	SIP Extension to notify SIP server that the unit is behind the NAT/Firewall. Do not configure it unless the server supports this special feature.
SIP Compact Header	Default is No. If set to Yes, the header is sent in compact format. This is helpful in stateless proxy with multiple codec used as big UDP packet is not router friendly during transit.
Voice Mail User ID	When configured, user can access VM messages by pressing “MSG” button. This ID is usually the VM portal access number, e.g.: 8500 in Asterisk or 8502 for FWD.
Send DTMF	This parameter specifies the mechanism to transmit DTMF digit. There are 3 supported modes: in audio which means DTMF is combined in audio signal (not very reliable with low-bit-rate codec), via RTP (RFC2833), or via SIP INFO.
Early Dial	Default is No . Use only if proxy or server supports 484 response.
Dial Plan Prefix	Sets the prefix added to each dialed number.

Dial Plan	<p>Dial Plan Rules:</p> <ol style="list-style-type: none"> Accept Digits: 1,2,3,4,5,6,7,8,9,0 , * , #, A,a,B,b,C,c,D,d Grammar: x - any digit from 0-9; <ul style="list-style-type: none"> xx+ - at least 2 digits number; xx. – at least 1 digit number. ^ - exclude; [3-5] - any digit of 3, 4, or 5; [147] - any digit 1, 4, or 7; <2=011> - replace digit 2 with 011 when dialing - or <ul style="list-style-type: none"> Example 1: {[369]11 1617xxxxxxx} – Allow 311, 611, 911, and any 11 digit numbers with leading digits 1617 Example 2: {^1900x+ <=1617>xxxxxxx} – Block any number of leading digits 1900 and add prefix 1617 for any dialed 7 digit numbers Example 3: {1xxx[2-9]xxxxxx <2=011>x+} –Allow any combinations of numbers with 11 digits which has a leading digit 1, but 5th digit cannot be 0 or 1. Or any length of numbers with a minimum of 2 digits beginning with 2, with the leading digit replaced with 011. Default: Outgoing - {x+}*x+} <p>Example of a simple dial plan used in a Home/Office in the US: { ^1900x. <=1617>[2-9]xxxxxx 1[2-9]xx[2-9]xxxxxx 011[2-9]x. [3469]11 }</p> <p>Explanation of example rule (reading from left to right):</p> <ul style="list-style-type: none"> • ^1900x. - prevents dialing any number started with 1900 • <=1617>[2-9]xxxxxx - allows dialing to local area code (617) numbers by dialing 7 numbers and 1617 area code will be added automatically • 1[2-9]xx[2-9]xxxxxx - allows dialing to any US/Canada Number with 11 digits length • 011[2-9]x. - allows international calls starting with 011 • [3469]11 - allow dialing special and emergency numbers 311, 411, 611 and 911 • [x+#] – more than two digits and end with a # sign. . NOTE: “Use # as Dial Key” “has to be disable in this case. • [x.#x+] - start with 0 or more digits and followed with “#”, and end with more than 1 digit. Valid: “1#2”. Invalid: “123” <p>Note: In some cases user wishes to dial strings such as *123 to activate voice mail or other application provided by service provider. In this case * should be predefined inside dial plan feature and the Dial Plan should be: { *x+ }.</p>
Delayed Call Forward Wait Time	Time waited before the call is forward to a number or VM. Default is 20 seconds.
Enable Call Features	Default is Yes . If set to "No", then Call Transfer, Call Forwarding & Do Not Disturb will be supported locally provided that the SIP server/proxy supports these features.
Session Expiration	<p>The SIP Session Timer extension enables SIP sessions to be periodically “refreshed” via a SIP request (UPDATE, or re-INVITE). Once the session interval expires, if there is no refresh via a UPDATE or re-INVITE message, the session is terminated.</p> <p>Session Expiration is the time (in seconds) where the session is considered timed out, provided no successful session refresh transaction occurs beforehand. The default value is 180 seconds.</p>
Min-SE	The minimum session expiration (in seconds). The default value is 90 seconds.
Caller Request Timer	If set to “Yes”, the phone will use session timer when it makes outbound calls if remote party supports session timer.

Callee Request Timer	If selecting “Yes”, the phone will use session timer when it receives inbound calls with session timer request.
Force Timer	If set to “Yes”, the phone will use session timer even if the remote party does not support this feature. If set to “No”, the phone enables the session timer only when the remote party supports this feature. To turn off Session Timer, select “No”.
UAC Specify Refresher	As a Caller, select UAC to use the phone as the refresher, or UAS to use the Callee or proxy server as the refresher.
UAS Specify Refresher	As a Callee, select UAC to use caller or proxy server as the refresher, or UAS to use the phone as the refresher.
Force INVITE	Session Timer can be refreshed using INVITE method or UPDATE method. Select “Yes” to use INVITE method to refresh the session timer.
Enable 100rel	The use of the PRACK (Provisional Acknowledgment) method enables reliability to SIP provisional responses (1xx series). This is very important in order to support PSTN inter-networking. To invoke a reliable provisional response, the 100rel tag is appended to the value of the required header of initial signaling messages.
Audio Call Ring Tone	There are 4 uniquely defined ring tones for Audio Only incoming calls: <ul style="list-style-type: none"> • 1 System Ring Tone: when selected, all calls will ring with system ring tone. • 3 Customer Ring Tones: when selected, incoming calls from this account will play selected ring tone.
Video Call Ring Tone	There are 4 uniquely defined ring tones for Video incoming calls: <ul style="list-style-type: none"> • 1 System Ring Tone: when selected, all calls will ring with system ring tone. • 3 Customer Ring Tones: when selected, incoming calls from this account will play selected ring tone.
Send Anonymous	If this parameter is set to “Yes”, the “From” header in outgoing INVITE message will be set to anonymous, essentially blocking the Caller ID from displaying.
Anonymous Call Rejection	Default is NO. If set to YES, anonymous call will be rejected
Refer-To Uses Target Contact	Default is NO. If set to YES, then for Attended Transfer, the “Refer-To” header uses the transferred target’s Contact header information.
Auto Answer	Default is No . If set to “Yes”, GXV300x will automatically switch on speaker to answer the incoming call after a short reminding beep. If set to “Intercom/Paging” mode, it will answer the call based on the SIP info header sent from the server/proxy.
Preferred Vocoder	The GXV300x supports up to 6 different Vocoder types including G.711 A-/U-law (nickname PCMU/PCMA), GSM, G.723.1, G.729A/B and G.726-32. User can configure Vocoders in a preference list that is included with the same preference order in SDP message. Enter the first Vocoder in this list by choosing the appropriate option in “Choice 1”. Similarly, enter the last Vocoder by choosing the option in “Choice 8”.
Preferred Video Coder	H.264, H.263 or H.263+. Codec H.264 is recommended.
Choose Video Codec By Local Preference	Default is No . If it is set to YES , we will choose the video codec using the configured preferred sequence when we receive an SDP offer.

Jitter Delay	Select desired Jitter Buffer Delay. Default is Medium. It is using 100, 200 and 400ms to match the setting of low, medium and high for audio. The video always buffered and played in synchronize with audio. Grandstream recommends “High” for a poor network environment.
Enable Video	Yes: video is enabled for all calls. This is the default value. No, but allow in-call enabling : <u>Receiving call:</u> There are two ways to pick up incoming video call. -Pressing SPEAKER or picking up handset will answer the call as VOICE ONLY call. GXV300x can still send out video request after the call is established by pressing MIRROR button. -Pressing MIRROR button will answer the call as VOICE & VIDEO call. <u>Making call:</u> -Picking up handset or pressing SPEAKER -Pressing MIRROR button to toggle between VOICE ONLY and VOICE & VIDEO No: video is disabled.
H.264 payload type	Enter a desired value (96-127) for dynamic RTP payload type of H.264 codec. Default is 99.
H.263+ payload type	Enter a desired value (96-127) for payload type of H.263+ codec. Default is 103
H.263 Default Resolution	Default is CIF.
Enable RFC5168 Support	Default is No . If it is set to Yes , phone will send an SIP INFO asking for update of I-frame.
SRTP Mode	Enable SRTP mode based on selection. Default is Disabled.
Special Feature	Default is Standard. Choose the selection to meet special requirements from different Soft Switch vendors (like Nortel, Broadsoft, Sonus, etc)

FXO SETTINGS

The FXO tab would only appear for GXV3005.

TABLE 14: FXO CONFIGURATION PAGE DEFINITIONS

Current Disconnect	This is a preconfigured value of duration for a line power drop used by specific service providers. For example, for a configured value of 500ms the device will ignore any random voltage drops on the line if duration of such drop is less than 500ms and the call will NOT be considered as terminated. This is useful to prevent unnecessary call drops in some low quality PSTN lines.
Enable Tone Disconnect	Default is Yes. If set Yes, busy tone is used as disconnect signal.

AC Termination Impedance	Selects the impedance of the analog line connected to the FXO port on GXV3005 Here is some basic information which may be helpful for initial configuration: 600 Ohm – North America; 270 Ohm + (750 Ohm 150 nF) -- Most of Europe 220 Ohm + (820 Ohm 120 nF) – Australia, New Zealand 220 Ohm + (820 Ohm 115 nF) – Austria, Bulgaria, Germany, Slovakia, South Africa 370 Ohm + (620 Ohm 310 nF) – UK., India
Silence Timeout	Terminate call after long silence detected. Default is 60 seconds, max 65536.
Caller ID Scheme	The GXV3005 supports 5 different types of schemes: 1. Bellcore (US standard) 2. ETSI_RING 3. ETSI_TAS 4. DTMF 5. NTT (Japanese standard) Please check with your PSTN service provider (or traditional PBX specs) for which caller ID scheme it supports.
Call Progress Tones	Using these settings, user can configure tone frequencies according to user preference. By default, the tones are set to North American frequencies. Frequencies should be configured with known values to avoid uncomfortable high pitch sounds. ON is the period of ringing (ON time in ms) while OFF is the period of silence. In order to set a continuous ring, OFF should be zero. Otherwise it will ring ON ms and a pause of OFF ms and then repeat the pattern. <ul style="list-style-type: none"> • “Dial tone” • “Ringback tone” • “Busy” • “Re-order tone” Please refer the document below to determine your local call progress tones: http://www.itu.int/ITU-T/inr/forms/files/tones-0203.pdf
Tx to PSTN Audio Gain(dB)	Allows user to set a value in dB for transmission to PSTN Audio Gain. Default is 1.
Rx to PSTN Audio Gain(dB)	Allows user to set a value in dB for receive from PSTN Audio Gain. Default is 0.

FXS SETTINGS

The FXS tab would only appear for GXV3006.

TABLE 15: FXS CONFIGURATION PAGE DEFINITIONS

Onhook Threshold	The amount of time the hookflash is pressed that will cause the device to onhook. Default is 800ms.
Onhook Voltage	The onhook voltage can be selected according to the line voltage depending on the analog phone used. The low power/high power will increase/decrease the output current. The default selection is 48V.

Volume Amplification	<p>Voice path volume adjustment.</p> <ul style="list-style-type: none"> • Rx is a gain level for signals <u>transmitted</u> by FXS • Tx is a gain level for signals <u>received</u> by FXS. <p>Default = 0dB for both parameters. Loudest volume: +6dB Lowest volume: -6dB.</p> <p>User can adjust volume of call on either end using the Rx Gain Level parameter and the Tx Gain Level parameter located on the FXS Port Configuration page.</p> <p>If call volume is too low when using the FXS port, adjust volume using the Rx Gain Level parameter under the FXS Port Configuration page.</p> <p>If voice volume is too low at the other end, user may increase the far end volume using the <u>Tx Gain Level</u> parameter under the FXS Port Configuration page.</p>
Caller ID Scheme	Default is Bellcore .
Disable FXS Caller ID	Default is No .
Enable FXS Call Waiting Caller ID	Default is No . If set to YES Call Waiting caller ID will not be provided to analog phone connected to this FXS port.
Distinctive Ring Tone	<p>This function lets you configure ring tone cadence preferences.</p> <p>Using these settings, user can configure tone frequencies according to user preference. By default, the tones are set to North American frequencies. Frequencies should be configured with known values to avoid uncomfortable high pitch sounds.</p>
FXS Ring Tone	This feature allows users to configure different ring tones for audio call/video call for different accounts.

SAVING THE CONFIGURATION CHANGES

After the user makes a change to the configuration, press the “Update” button in the Configuration Menu. The web browser will then display a message window to confirm saved changes.

Grandstream recommends reboot or power cycle the IP phone after saving changes.

REBOOTING THE PHONE REMOTELY

Press the “Reboot” button at the bottom of the configuration menu to reboot the phone remotely. The web browser will then display a message window to confirm that reboot is underway. Wait 30 seconds to log in again.

CONFIGURATION THROUGH SECURE CENTRAL PROVISIONING SERVER

Grandstream GXV300x can be automatically configured from a central provisioning system.

When GXV300x boot up, it will send TFTP or HTTP request to download configuration file, "cfg000b82xxxxx", where "000b82xxxxx" is the LAN MAC address of the GXV300x.

The configuration file can be downloaded via TFTP or HTTP/HTTPS from the central server. A service provider or an enterprise with large deployment of GXV300x can easily manage the configuration and service provisioning of individual devices remotely from a central server.

Grandstream has a provisioning system called GAPS (Grandstream Automated Provisioning System) that is used to support automated configuration of Grandstream devices. GAPS uses enhanced (NAT friendly) TFTP or HTTP (thus no NAT issues) and other communication protocols to communicate with each individual Grandstream device for firmware upgrade, remote reboot, etc.

Grandstream provides GAPS service to VoIP service providers. Use GAPS for either simple redirection or with certain special provisioning settings. At boot-up, Grandstream devices by default point to Grandstream provisioning server GAPS, based on the unique MAC address of each device, GAPS provision the devices with redirection settings so that they will be redirected to customer's TFTP or HTTP/HTTPS server for further provisioning. Grandstream also provide GAPSLITE software package which contains our NAT friendly TFTP server and a configuration tool to facilitate the task of generating device configuration files.

The GAPSLITE configuration tool is now free to end users. The tool and configuration template are available for download from <http://www.grandstream.com/support/configurationtool.html> .

SOFTWARE UPGRADE & CUSTOMIZATION

Software (or firmware) can be upgraded using either TFTP or HTTP. The corresponding configuration settings are in the ADVANCED SETTINGS configuration page.

FIRMWARE UPGRADE THROUGH TFTP/HTTP

To upgrade via TFTP or HTTP, select TFTP or HTTP upgrade method. “Upgrade Server” needs to be set to a valid IP or URL of a HTTP server. Server name can be in either FQDN or IP address format. Here are examples of some valid URLs.

- firmware.mycompany.com:6688/Grandstream/1.2.2.5
- 72.172.83.110

There are two ways to set up the Upgrade Server to upgrade firmware: Key Pad Menu and Web Configuration Interface.

Key Pad Menu

To configure the Upgrade Server via Key Pad Menu options, select “System Config” from the Main Menu, then select “Upgrade Preferences”. Under this sub Menu, user can edit Upgrade Server in either an IP address format or FQDN format. Choose “*Save and use TFTP*” or “*Save and use HTTP*” to select upgrade method. Select “Reboot” from the Main Menu to reboot the phone.

Web Configuration Interface

To configure the Upgrade Server via the Web configuration interface, open the web browser. Enter the GXV300x IP address. Enter the administrator password to access the web configuration interface. In the ADVANCED SETTINGS page, enter the Upgrade Server’s IP address or FQDN in the “Upgrade Server” field. Select TFTP or HTTP upgrade method. Update the change by clicking the “Update” button. “Reboot” or power cycle the phone to update the new firmware.

During this stage, the LCD will display the firmware file downloading process and flashing process. Please do NOT interrupt this process and make sure NO power outage at this stage.

If a firmware upgrade fails for any reason, the phone will stop the upgrading process and re-boot using the existing firmware.

NOTE: If the phone cannot boot up, user can force the phone to load the internal stored booting code by pressing the “#” and “*” key simultaneously and power on the phone. Then flash the phone again using the correct firmware files.

Firmware upgrades may take 5 minutes in a controlled LAN environment or up to 45 minutes over the public Internet. Grandstream recommends download firmware file and complete firmware upgrade process in a controlled LAN environment whenever possible.

No Local TFTP Server

For users who do not have local TFTP server, Grandstream provides a NAT-friendly TFTP server on the public Internet for users to download the latest firmware upgrade automatically. Please check the Support/Download section of our website to obtain this TFTP server IP address: <http://www.grandstream.com/firmware.html> . Each product has a unique TFTP server address.

Alternatively, download and install a free TFTP or HTTP server and perform firmware upgrades. Free Windows version TFTP server is available: <http://support.solarwinds.net/updates/New-customerFree.cfm>. Or <http://tftpd32.jounin.net/>.

Instructions for firmware upgrade via a Local TFTP Server:

1. Unzip the file and put all of them under the root directory of the TFTP server.
2. The PC running the TFTP server software and the GXV300x should be in the same LAN segment.
3. Make sure the firmware files are in the correct root folder of TFTP server. If using Solarwinds free TFTP server, make sure changing the TFTP server's default setting from "Receive Only" to "Transmit Only" for the firmware upgrade. Then start the server by running the TFTP server software.
4. In the phone's web configuration page, configure the Firmware Server Path to the IP address of the PC running the TFTP software.
5. Update the change and reboot the phone.

You can also download the free HTTP server from <http://httpd.apache.org/> or use Microsoft IIS web server embedded in some version of Windows OS.

NOTE: When GXV300x phone boots up, it will send TFTP or HTTP request to download configuration file "cfg000b82xxxxx", where "000b82xxxxx" is the MAC address of the GXV300x phone. This file is for *initial* provisioning purpose only. For normal TFTP or HTTP firmware upgrades, the following error messages in a TFTP or HTTP server log can be ignored: "TFTP Error from [IP ADDRESS] requesting cfg000b82023dd4 : File does not exist. Configuration File Download".

CONFIGURATION FILE DOWNLOAD

The GXV300x can be configured via Web Interface as well as via Configuration File through TFTP or HTTP. "Config Server Path" is the TFTP or HTTP server path for the configuration file. It needs to be set to a valid URL, either in FQDN or IP address format.

The configuration parameter is associated with each particular field in the web configuration page. A parameter consists of a capital letter **P** and 2 or 3 (could be extended to 4 in the future) digit numeric numbers. i.e., P2 is associated with "Admin Password" in the ADVANCED SETTINGS page. For a detailed parameter list, please refer to the corresponding configuration template of the firmware.

Once the GXV300x boots up (or re-booted), it will request a binary configuration file named "cfgxxxxxxxxxx", where "xxxxxxxxxx" is the MAC address of the device, i.e., "cfg000b820102ab". The configuration file name should be in lower cases.

NOTE: For earlier hardware versions (prior to V1.1), a manual power cycle is required if the LCD is pale or changes to the color white after firmware upgrade or configuration file downloading. For hardware versions after V1.1, the GXV300x automatically reboots itself after such process.

If the firmware crashes for an unknown reason during upgrade and the phone cannot boot up, please press "#" and "*" keys simultaneously then power up the phone. This will force the phone to load the stored boot file so that user can flash the phone again with good firmware files.

MANAGING FIRMWARE AND CONFIGURATION FILE DOWNLOAD

When “Automatic Upgrade” is set to “Yes”, Service Provider can use P193 (Auto Check Interval, in minutes, default and minimum is 60 minutes) to have the device periodically checked for upgrades at pre-scheduled time intervals. By defining different intervals in P193 for different devices, a Server Provider can manage and balance the Firmware or Provisioning Server load at any given time.

GXV CUSTOMIZATION

XML PHONEBOOK

Introduction

The Grandstream GXV enables you to easily share and maintain a phonebook through the web. The XML-phonebook must be stored on a web-server. There are also applications where organizations wish to be able to have a centralized directory server and have all phones in the organization to sync up with the server periodically.

How It Works and Configuration

A new set of configuration options will be introduced as following:

- Enable Downloadable Phonebook (P330): NO/YES-HTTP/YES-TFTP (default NO). Possible values 0 (NO)/1 (HTTP)/2 (TFTP), other values ignored.
- Phonebook XML Path (P331): This is a string of up to 128 characters that should contain a path to the XML file. It MUST be in the host/path format. For example: "directory.grandstream.com/engineering"
- Phonebook Download Interval (P332): This is an integer variable in hours. Valid value range is 0-720 (default 0), and greater values will default to 720.
- Remove manually edited entries on download: YES/NO (default NO) P333, possible values 0/1, other values ignored

The feature will be activated when "Enable Downloadable Phonebook" is set to YES (HTTP or TFTP) AND a valid "Phonebook XML Path" is set.

When the device boot up and completed the provisioning routine, it will attempt to download the gs_phonebook.xml file specified in "Phonebook XML Path" and process it as described in the next chapter. Please note that the phonebook file name is fixed, so you can not alter the phonebook file name based on your preference. During this process the LCD should display some messages to indicate that XML Phonebook download is in progress.

If the "Phonebook Download Interval" is set to a non-zero value a recurring timer will be fired to periodically check that would repeat this process automatically.

When the XML file is downloaded, we will parse it and extract the entries from it. If the "Remove manually edited entries on download" option is set to No (by default), the device will keep ALL stored entries manually edited before, and insert the downloaded entries, and then save the phonebook. Otherwise ALL the existing phonebook entries on the phone will be erased and filled with the downloaded entries.

At any time, you can trigger an immediate download from by choosing the “Download Phonebook” in the GUI Phone Book Menu (you can use the down arrow key when the phone is on-hook).

XML Syntax

XSD file

```
<?xml version="1.0"?>
<xsd:schema xmlns:xsd="http://www.w3.org/2001/XMLSchema">
  <xsd:element name="AddressBook">
    <xsd:complexType>
      <xsd:sequence>
        <xsd:element name="Contact" minOccurs="1" maxOccurs="unbounded">
          <xsd:complexType>
            <xsd:sequence>
              <xsd:element name="LastName" type="xsd:string" minOccurs="1"/>
              <xsd:element name="FirstName" minOccurs="0" type="xsd:string" nillable="true"/>
              <xsd:element name="Address" minOccurs="0" nillable="true">
                <xsd:complexType>
                  <xsd:sequence>
                    <xsd:element name="address1" type="xsd:string" minOccurs="1" maxOccurs="1"/>
                    <xsd:element name="address2" type="xsd:string" minOccurs="0" maxOccurs="1"/>
                    <xsd:element name="city" type="xsd:string" minOccurs="1" maxOccurs="1"/>
                    <xsd:element name="state" type="xsd:string" minOccurs="1" maxOccurs="1"/>
                    <xsd:element name="zipcode" type="xsd:string" minOccurs="1" maxOccurs="1"/>
                    <xsd:element name="country" type="xsd:string" minOccurs="1" maxOccurs="1"/>
                  </xsd:sequence>
                </xsd:complexType>
              </xsd:element>
            <xsd:element name="Phone">
              <xsd:complexType>
                <xsd:sequence>
                  <xsd:element name="phonenumber" type="xsd:string" minOccurs="1" maxOccurs="1"/>
                  <xsd:element name="accountindex" type="xsd:integer" minOccurs="1" maxOccurs="1"
                    default="1"/>
                </xsd:sequence>
              </xsd:complexType>
            </xsd:element>
          <xsd:element name="Email" type="xsd:string" minOccurs="0" nillable="true"/>
          <xsd:element name="Department" type="xsd:string" minOccurs="0" nillable="true"/>
          <xsd:element name="Company" type="xsd:string" minOccurs="0" nillable="true"/>
          <xsd:element name="Icon" type="xsd:base64Binary" minOccurs="0" nillable="true"/>
        </xsd:sequence>
      </xsd:complexType>
    </xsd:element>
  </xsd:sequence>
</xsd:schema>
```

Example Phonebook File

```
<?xml version="1.0"?>
<AddressBook>
  <Contact>
    <LastName>Doe</LastName>
    <FirstName>John</FirstName>
    <Phone>
      <phonenumber>8000</phonenumber>
      <accountindex>0</accountindex>
    </Phone>
  </Contact>
  <Contact>
    <LastName>Smith</LastName>
    <FirstName>Alan</FirstName>
    <Phone>
      <phonenumber>8001</phonenumber>
    </Phone>
  </Contact>
</AddressBook>
```

```

    <accountindex>0</accountindex>
  </Phone>
</Contact>
<Contact>
  <LastName>Lee</LastName>
  <FirstName>Lily</FirstName>
  <Phone>
    <phonenumber>6000</phonenumber>
    <accountindex>1</accountindex>
  </Phone>
</Contact>
</AddressBook>

```

SCREENSAVER IMAGES

Customize the screensaver images by using the free “Screensaver Generation Tool” downloadable from <http://www.grandstream.com/resources.html>

Personalize the screensaver by downloading your favorite pictures. Picture requirements:

- Baseline JPEG
- 320x240 in dimension
- RGB color space
- 8-bit data

The screensaver file (**image.bin**, cannot rename this file) is limited to 20 images or 320kb, whichever limit is reached first. Screensaver pictures, as well as the customized ring tones, are flashed into the phone the same way to upgrade firmware. Just put the files together with firmware files.

Grandstream recommends that you resize pictures using popular photo processing software. The following screen shots are resize pictures using Adobe Photoshop:

FIGURE 6: SIZING THE SCREENSAVER

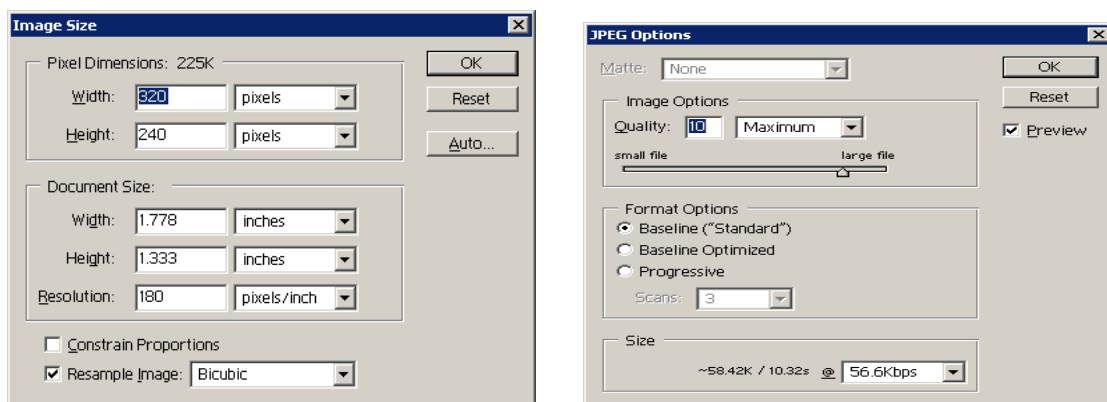

NOTE: Picture MUST be preprocessed and resized to 320 x 240 and picture must be saved in Baseline JPEG format. Otherwise it will not be shown in the LCD screen of the phone.

FIGURE 7: SCREENSHOT OF SCREENSAVER UTILITY

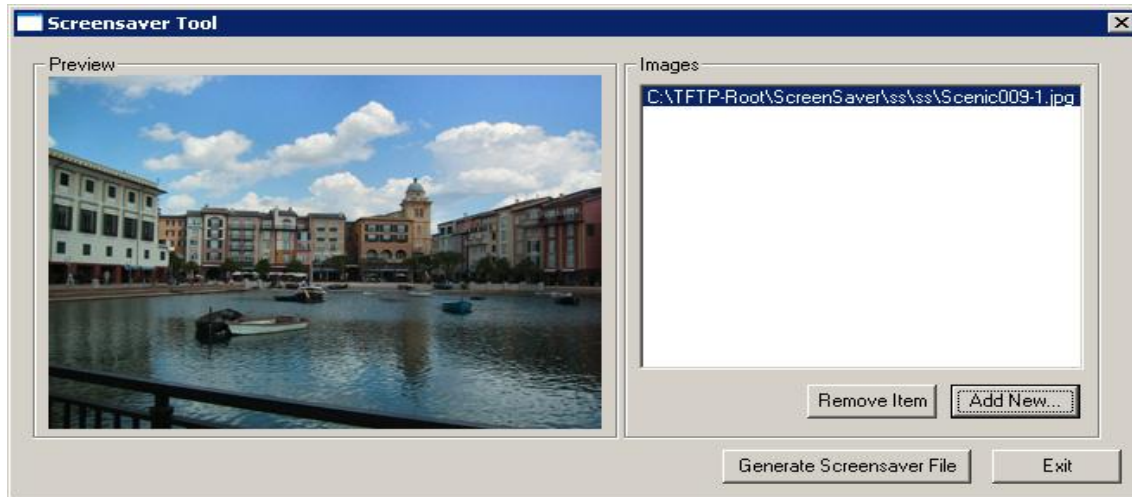

- Remember the limitation of the **image.bin** file (20 images or 320kb)
- Put the generated file (image.bin) into the same folders as the firmware files
- Reboot or Power cycle the phone and wait image.bin file downloaded successfully.

CAUTION: Please do not interrupt the power supply during file downloading. You may damage the phone. For users who experience frequent power outages, Grandstream recommends using UPS prior to configuration file downloads or firmware upgrade.

CUSTOMIZED RING TONES

Download the free Ring Tone Generation Tools from <http://www.grandstream.com/resources.html>

Please follow the same rules as above [Screensaver Images](#) to generate the ring tone files and load them into the phone.

Ring-tone File Size

File requirements for ring tone conversion:

1. Must be either .wav or .mp3 format [recommend .wav format]
2. Converted file size must be less than 64KB other wise it will override next file slot space.
3. Flash only has space to store 3 ring tone files (64KB x 3 = 192KB total space)

The ring tone generator supports 16-bit linear PCM as input (*not* PCMU or PCMA).

If a ring tone file is larger than 64KB, it will occupy the next available ring tone file slot. For example: If the 2nd ring tone file size is more than 64KB (but less than 128KB), the 3rd "ring3.bin" will not have enough storage space and it will not be able to load into the phone.

The ring tone files must follow the following naming convention: "ring1.bin", "ring2.bin", and "ring3.bin". Ring tone files can not be renamed.

FIGURE 8: SCREENSHOT OF RING TONE GENERATING UTILITY

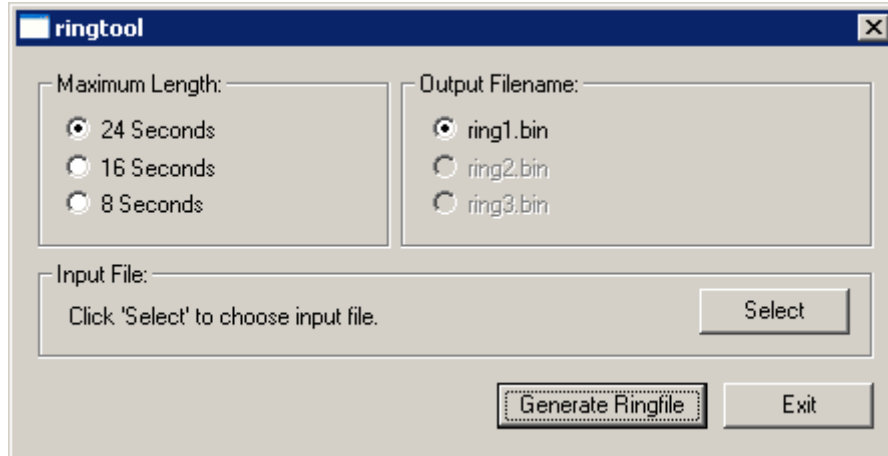

AUXILIARY PORTS

USB 2.0 PORT

When a USB flash drive is connected to a USB 2.0 port, an icon is displayed in the lower left section of the LCD. Same when USB keyboard or mouse plugged into the ports for mini browser usage.

CAPTURE PICTURES VIA USB PORT

Once a USB flash drive is connected and ready for use (an icon will show up in lower part of the LCD), the user can save a snap shot or capture a picture from camera to the flash drive.

Directions:

When the USB flash drive device is ready (either the video phone is in camera local loopback mode or in a live video call), press “OK” key once. The LCD will freeze for 1 or 2 seconds and the captured frame or picture will be saved in the flash drive using this naming convention: “**gxv_xxx.bmp**”.

Only one picture can be saved at a time when the “OK” key be pressed.

CONNECT THE GXV300x TO YOUR TV using RCA Cable

FIGURE 9: TV / GXV300X DIAGRAM

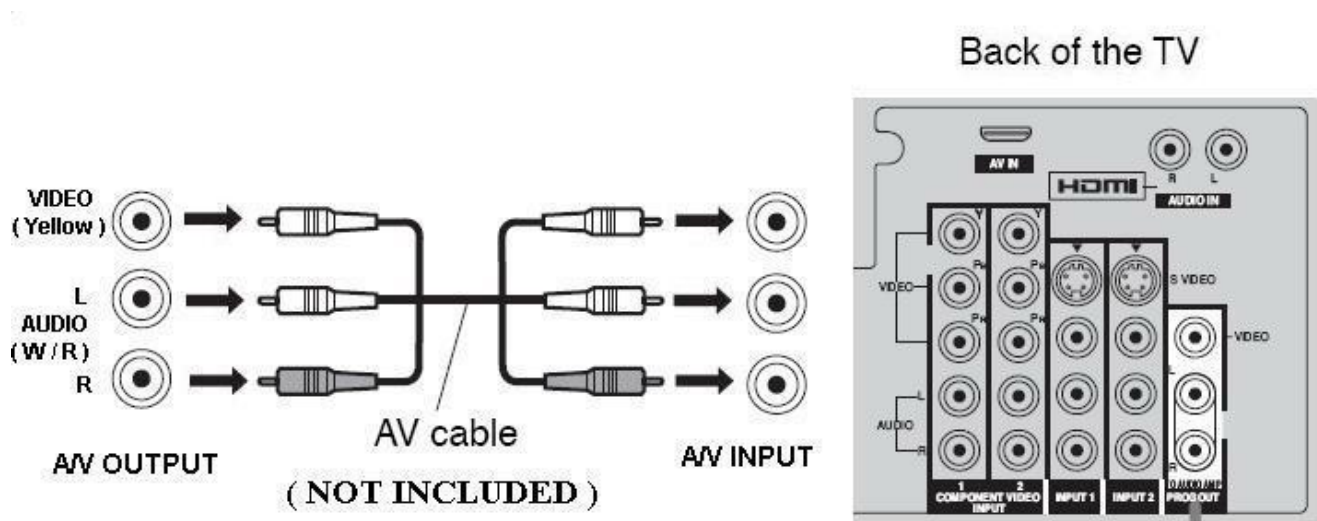

Headset Jack

FIGURE 10: HEADSET JACK DIAGRAM

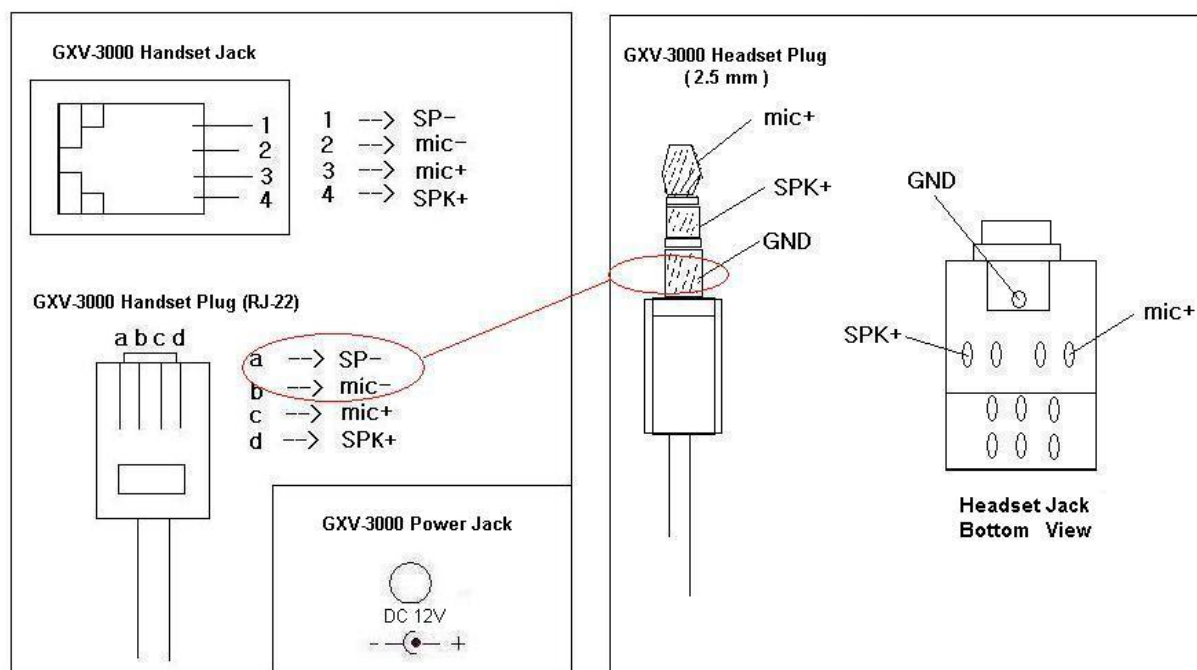

The left side of the diagram illustrates the RJ22 (handset plug) pin assignment; the right side illustrates the 2.5mm headset plug. Additional adaptors are necessary to connect the phone to an external speaker or intercom/paging system. (Adaptors can be purchased from an local electronics store).

Cross Over Cable For Some Model of Headset

If you want to use headset products with an RJ22 plug, a special cable (known as cross-over cable) or a cable adapter box is required. The standard handset cable (supplied with the headset) is a roll-over cable standard for ALL handsets using RJ22 plug.

The default handset plug PIN lay out is China standard (Made in China). US and European customers cannot use local popular RJ22 headsets without adjusting the connection wiring as follows:

EXAMPLE: CONNECTING A PLANTRONICS M12 HEADSET USING CLAMPING TOOLS AND RJ22 PLUG

Here are the schemas of the two cables; the plug viewed with Pin side facing user, and PINs layout as specified above in the diagram:

d: SP + c: Mic +
a: SP - b: Mic -

FIGURE 11: HEADSET CROSS-OVER DIAGRAMS

Roll Over Cable (already provided, to connect the handset to phone base)

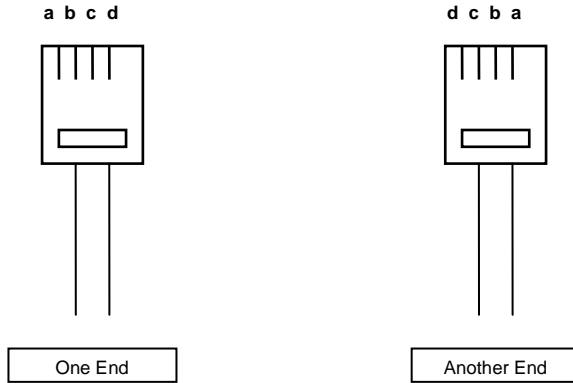

Cross Over Cable (required for Plantronics Headset)

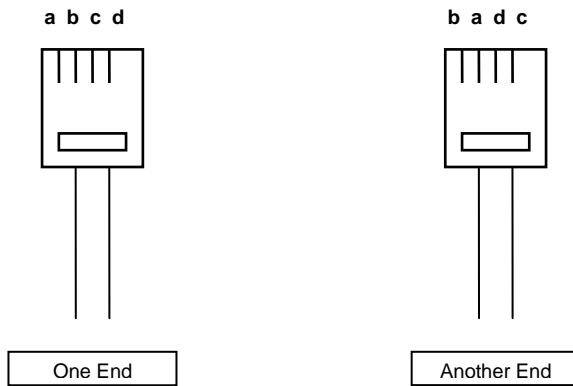

VIDEO SURVEILLANCE

To use the GXV300x as a video surveillance camera, please configure the GXV300x and the monitor PC in the same LAN environment. Advanced users may manipulate it to work over WAN (*configuration not recommended and not covered in this User Manual*). For best results, Grandstream recommends using this feature in the same LAN environment or ensure both monitor PC and phone have static public IP address.

VIDEO SURVEILLANCE CONFIGURATION DIRECTIONS

Phone side: In the ADVANCED SETTING page, find the following field and change the default setting from “NO” to “YES”: reboot the device.

Enable Video Surveillance: No Yes

PC side (Monitor Device):

1. Download VLC from <http://www.videolan.org/vlc/>. (**Version 0.8.5 ONLY**). This is the only free open source player that supports both the Grandstream device and RFC 3984.
2. Launch VLC.
3. Go to Preferences ->Input/Codecs ->Demuxers ->H264. Check “Advanced Options” in the bottom. Change “Frames per Second” value to 5 and then save.
4. Go to Preferences ->Input/Codecs ->Access modules ->Real RTSP. Check “Advanced Options” in the bottom. The option will show. Change “Caching value (ms)” value to 1000 and then save. You may change it to a smaller value to reduce the delay.
5. Close the Preferences window and go to File ->Open Network Stream:
 - Select RTSP as the protocol
 - Enter the URL in the “Customize” field using the format:
`rtsp://admin:ADMIN_PASSWORD@DEVICE_IP_ADDRESS:DEVICE_RTSP_PORT`.
 - Change the text in red to your own configuration parameter:
 - i. ADMIN_PASSWORD is the phone’s administrator password for WebUI.
 - ii. DEVICE_IP_ADDRESS is the phone’s IP.
 - iii. DEVICE_RTSP_PORT is the RTSP port setting of the device. If the phone is using default value 554, omit the port portion from the URL
 - Click OK or enter Return key. Start viewing the video surveillance from the PC.

Limitations:

1. Video surveillance supports only *two* (2) concurrent viewers on the GXV. The video stream is set at 5 frame per second and 128kbps.
2. The video stream will stop if a call starts. The video stream server (the phone) will not actively terminate the session. Most clients (the VLC software in PC) will terminate the session after certain interval of time. A restart of the VLC software is required to view the surveillance again.

FIGURE 12: SCREENSHOT – MONITORING STATION





RESTORE FACTORY DEFAULT SETTING

WARNING: Restoring the Factory Default Setting will **delete** all configuration information of the phone. Please **backup** or **print** all the settings before you restoring factory default settings. Grandstream is not responsible for restoring lost parameters and cannot connect your device to your VoIP service provider.

INSTRUCTIONS FOR RESTORATION:

Step 1: Press “OK” button to bring up the keypad configuration menu, select “Config”, press “OK” to enter submenu, select “Factory Reset” (Please refer to Table 5-1 of keypad flow chart)

Step 2: Enter the MAC address printed on the bottom of the sticker. Please use the following mapping:

- 0-9: 0-9
- A: 22 (press the “2” key twice, “A” will show on the LCD)
- B: 222
- C: 2222
- D: 33 (press the “3” key twice, “D” will show on the LCD)
- E: 333
- F: 3333

Example: if the MAC address is 000**b**8200**e**395, it should be key in as “000**222**8200**333**395”.

NOTE: If there are digits like “22” in the MAC, you need to type “2” then press “->” right arrow key to move the cursor or wait for 4 seconds to continue to key in another “2”.

Step 3: Press the “OK” button to move the cursor to “OK”. Press “OK” button again to confirm. If the MAC address is correct, the phone will reboot. Otherwise, it will exit to previous keypad menu interface.