

Panasonic

Digital Proprietary Telephones
for Digital Super Hybrid Systems

Operating Instructions

Model **KX-T7425**
KX-T7433
KX-T7436
KX-T7450



KX-T7436

Please read this manual before
using the Digital Proprietary Telephone.

Thank you for purchasing a Panasonic Telephone.

Accessories

When unpacking, check the following items.

Handset	one
Telephone line cord	one
Handset cord	one
Overlay	one (KX-T7433, KX-T7436 only)
Card holder with memory station card	one (KX-T7425 only)

Note:

- In this manual, the suffix of each model number is omitted.
- This device is equipped with pulse dialling while the telecom standard is DTMF tone dialling. There is no guarantee that the Telecom Lines will always continue to support pulse dialling.*

Caution

When using the KX-T7400 series, keep the following conditions in mind.

- If there is any problem, unplug the extension line and connect a known working phone. If the known working phone operates properly, have the defective phone repaired by a specified Panasonic Factory Service Centre. If the known working phone does not operate properly, check the Digital Super Hybrid System and the internal extension wiring.
- Keep the unit away from heating appliances and electrical noise generating devices such as fluorescent lamps and motors.
- The unit should be kept free of dust, moisture and vibration, and should not be exposed to direct sunlight.
- Do not use benzine, thinner, or any abrasive powder to clean the cabinet. Wipe it with a soft cloth.
- Do not use any handset other than a Panasonic handset.

WARNING:

TO PREVENT FIRE OR SHOCK HAZARD, DO NOT EXPOSE THIS PRODUCT TO RAIN OR ANY TYPE OF MOISTURE.

- When a failure occurs which results in the internal parts becoming accessible, disconnect the telephone line cord immediately and return this unit to service center.
- This equipment shall not be set to make automatic calls to telecom 111 Emergency service.*

IMPORTANT NOTICE:

Under power failure conditions, this telephone may not operate. Please ensure that a separate telephone, not dependent on local power, is available for emergency use in emergencies.

* The regulation is applied in New Zealand only.

Contents

Location of Controls	4
Getting Started	6
Connection.....	6
Controlling the volume/adjusting the display contrast.....	7
Description of the symbols.....	7
Making Calls	8
Calling.....	8
Speed dialing.....	8
One-touch dialing	8
Dialing the last number you dialed (Last Number Redial).....	8
Receiving Calls	9
Receiving calls	9
Handsfree answerback.....	9
Picking up a call for someone else (Call Pickup).....	9
When the Dialed Extension is Busy/No Answer	10
Reserving a busy line (Automatic Callback Busy)	10
Leaving a call notification (Message Waiting)	10
Calling Back	11
When you receive a notification (Message Waiting)	11
Calling using the call log (Incoming Call Log)	11
During a Conversation	12
Placing a call on hold.....	12
Off-hook Monitor.....	12
Transferring a call.....	13
Paging	13
Paging a person and transferring a call.....	14
Answering an announced page	14
Answering a call waiting.....	14
Useful Features	15
Forwarding your calls (Call Forwarding).....	15
Preventing others from disturbing you (Do Not Disturb [DND]).....	17
Three-party conversation (Conference).....	17
Ringing tone selection for CO buttons.....	18
Storing numbers for One-touch dialing.....	18
How to Use the Display	19
Using the Jog Dial	19
KX-T7433.....	20
KX-T7436.....	22
Storing in Speed Dialing	24
Storing names and numbers at your extension for personal use.....	24
Storing names and numbers in the system	26
Wall Mounting	27
Installing the Card Holder	28
Features List	29

Location of Controls

KX-T7433

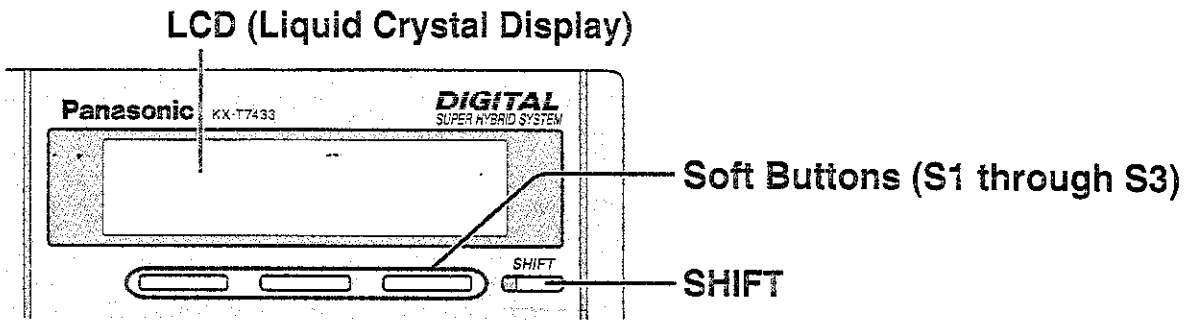



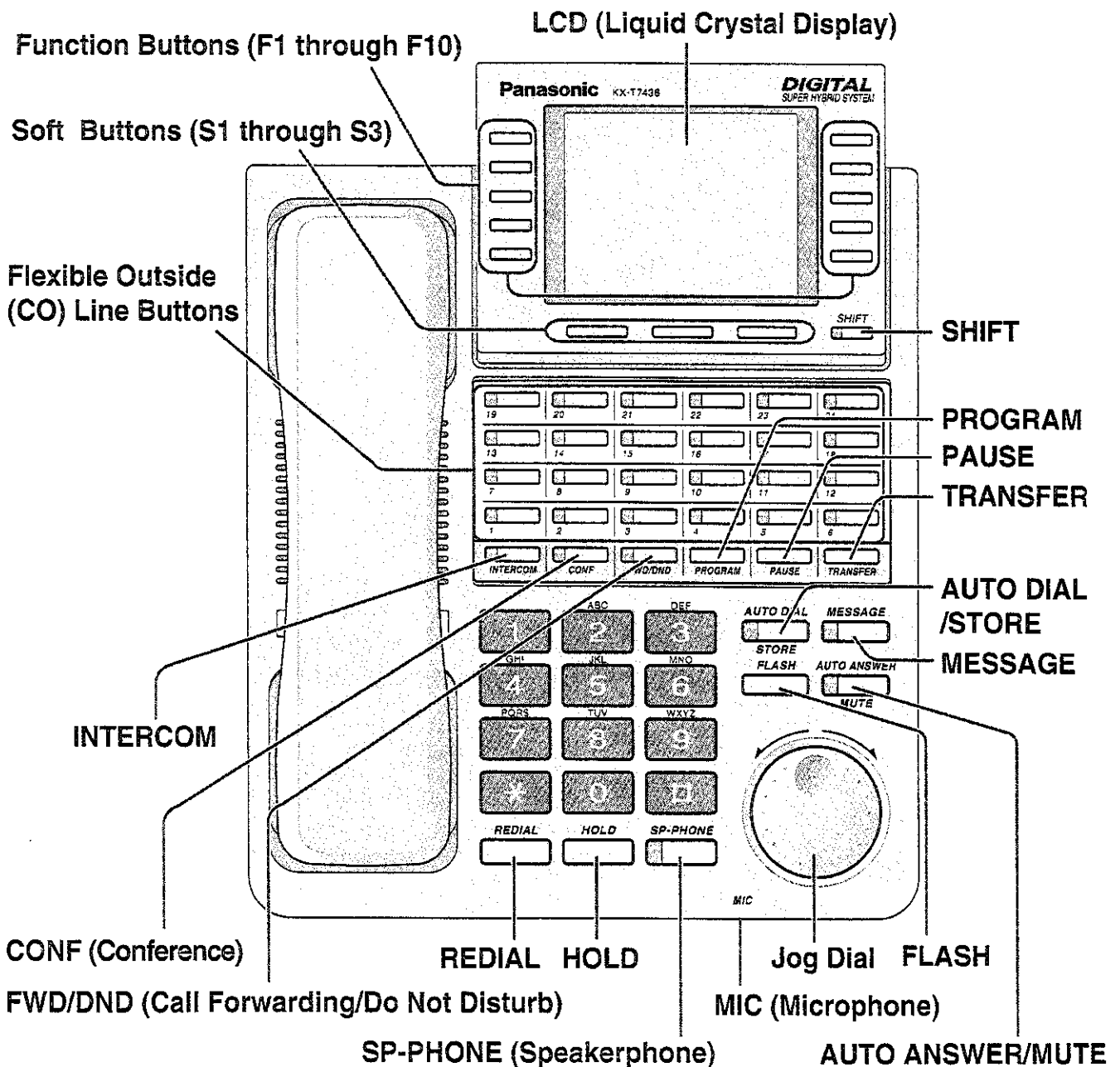





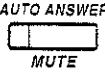











KX-T7436



* The display is not available for the KX-T7425.

The display and Microphone are not available for the KX-T7450.

- AUTO ANSWER**
 Used to answer an intercom call automatically.
- VOICE CALL (KX-T7450 only)**
 Used to monitor an intercom call automatically.
- MUTE**
 Used to listen to the other party without them hearing you. You can mute the handset microphone or the microphone.
-
- AUTO DIAL/STORE**
 Used for speed dialing in the system or storing program changes.
- CONF**
 Used to make a three-party conference.
- FLASH**
 Used to disconnect the current call and make another call with holding the same outside line.
- Flexible Outside (CO) Line Button**
 Used to make or receive an outside call, or access a feature if the button is assigned as a One-touch dialing button.
- Function Button**
 Used to perform the displayed function or operation.
- FWD/DND**
 Used to perform Call Forwarding or Do Not Disturb.
- HOLD**
 Used to place a call on hold.

- INTERCOM**
 Used to make or receive intercom calls.
-
- Jog Dial**
 Used to search the stored telephone numbers or system features and adjust the volume or the display contrast.
-
- MESSAGE**
 Used to leave a notification or call back the party who left the notification.
-
- PAUSE**
 Used to insert a pause in speed dial numbers or in other numbers.
-
- PROGRAM**
 Used to enter and exit the programming mode.
-
- REDIAL**
 Used to redial.
-
- SHIFT**
 Used to alternate the sub function on the display.
-
- Soft Button**
 Used to perform the function or operation that appears on the bottom line of the display.
-
- SP-PHONE**
 Used for the handsfree operation.
- MONITOR (KX-T7450 only)**
 Used for the handsfree dialing. You can monitor the party's voice handsfree.
-
- TRANSFER**
 Used to transfer a call to another party.

For KX-T7433 and KX-T7436 Users

The display can be adjusted.

- 1 Press the **LCD ADJ** button.
- 2 Lift or put down the display.

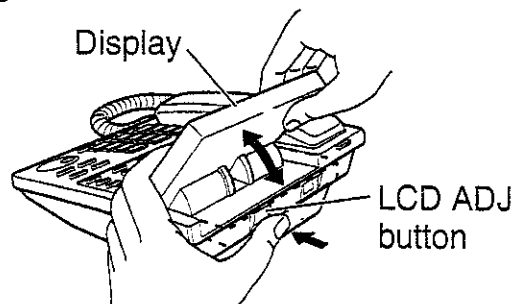

Getting Started

■ Connection

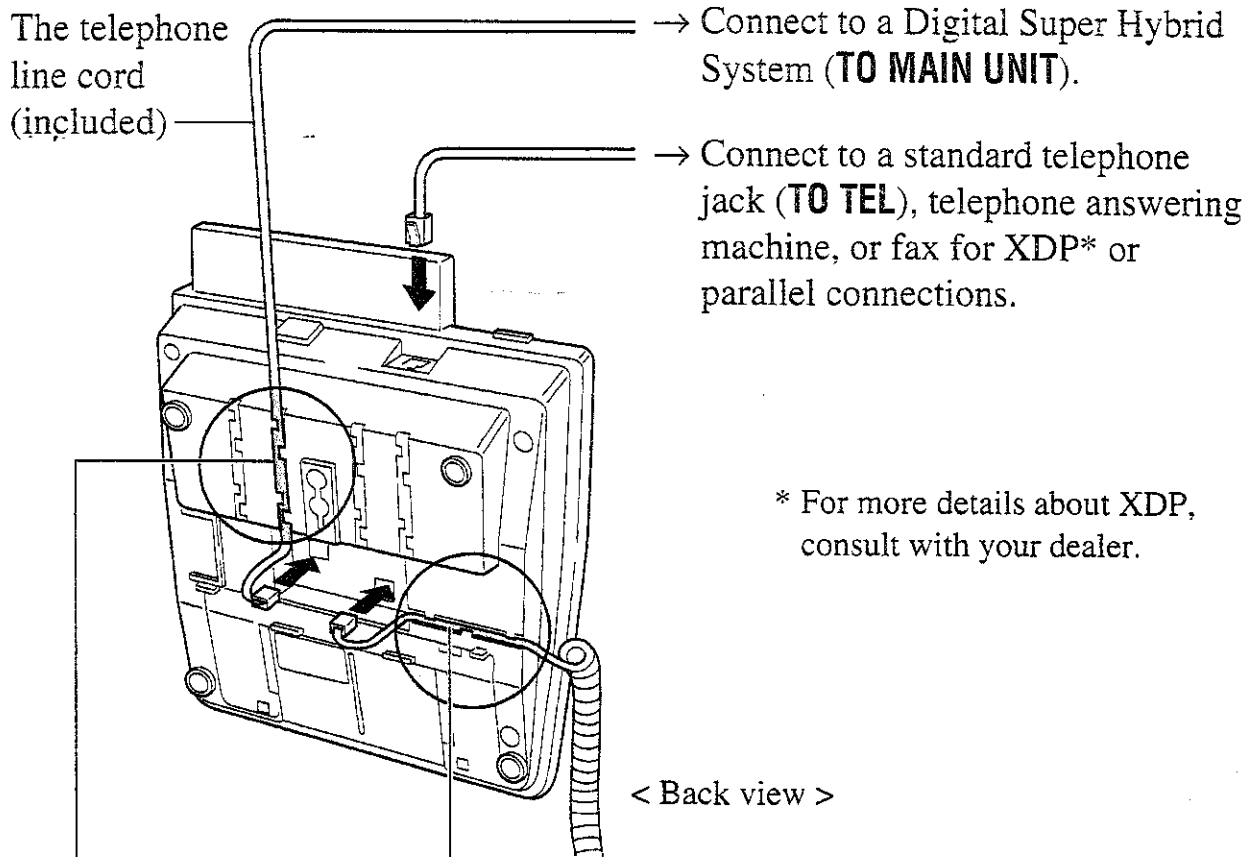

CAUTION

Ensure the cords are inserted in the grooves to prevent damage to the connectors.

Helpful hints for the handsfree operation

- **If the other party's voice is difficult to hear:**
Raise the sound level using the speaker volume control.
- **If the other party has difficulty hearing you:**
Lower the speaker volume.
- **Absorbing echoes:**
Use this unit in a room which has curtains and/or carpeting.
- **To avoid missing part of the conversation:**
If you and the other party speak at the same time, parts of your conversation will be lost. To avoid this, speak alternately.

■ Controlling the volume/adjusting the display contrast

Speaker volume

- 1 Press the **SP-PHONE/MONITOR** button.
- 2 Rotate the **Jog Dial** in the desired direction.

Handset/Headset volume

- 1 Lift the handset.
(Press the **SP-PHONE/MONITOR** button for headset volume.)
- 2 Rotate the **Jog Dial** in the desired direction.

For KX-T7425 and KX-T7450 Users

Ringer volume

- 1 Adjust the **RINGER Volume selector** lever to the desired setting (**OFF/LOW/HIGH**).

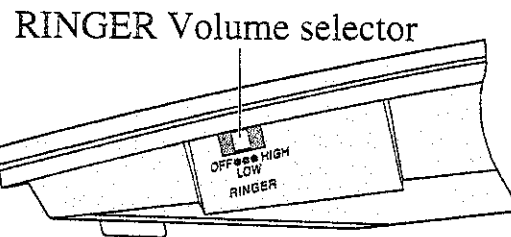

<Side view of the KX-T7425 and KX-T7450>

For KX-T7433 and KX-T7436 Users

Display contrast

While on-hook or during a conversation

- 1 Press the **CONT (S1)** button.

Display: Contrast: * * *

- 2 Rotate the **Jog Dial** in the desired direction.

Ringer volume

While idle and on-hook

- 1 Press the **RING (S2)** button.

Display: Ringer: * * *

- 2 Rotate the **Jog Dial** in the desired direction.

■ Description of the symbols

In this manual, many symbols are used. Some of the symbols are described below.



Off-hook

- Lift the handset.
or
- Press the **SP-PHONE** button.
or
- Press the **MONITOR** button.
(To start talking, lift the handset.)



Press the desired number keys on the telephone.



On-hook

- Replace the handset.
or
- Press the **SP-PHONE** button.
or
- Press the **MONITOR** button.



Various tones are heard depending on the operation.

Making Calls

Calling

To an extension

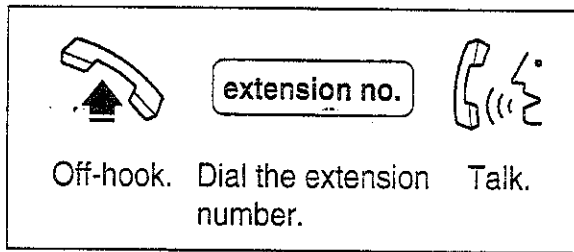

To an external party

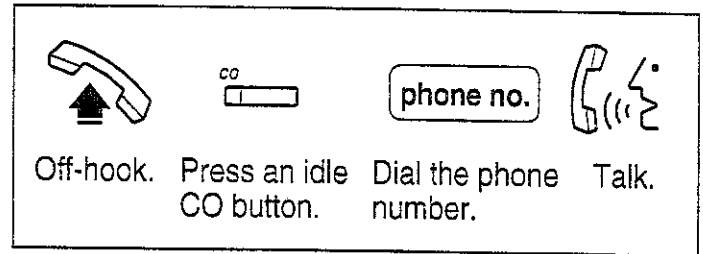

Speed dialing

Using a speed dial number stored in your telephone

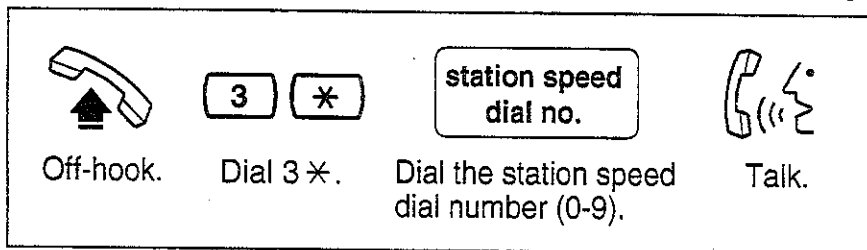

To store numbers, refer to page 24.

Using a speed dial number stored in the system

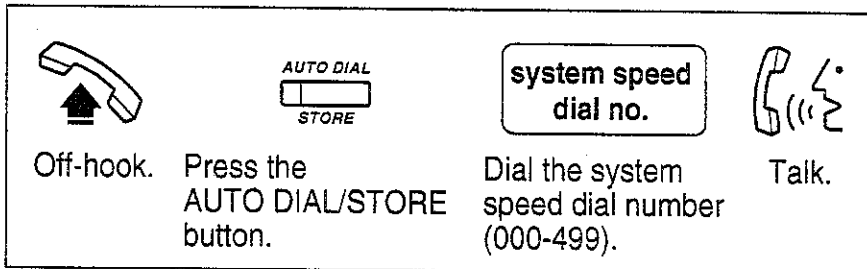

To store numbers, refer to page 26.

One-touch dialing

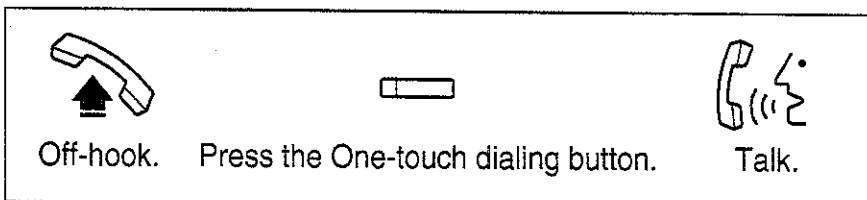

To store numbers, refer to page 18.

Dialing the last number you dialed (Last Number Redial)

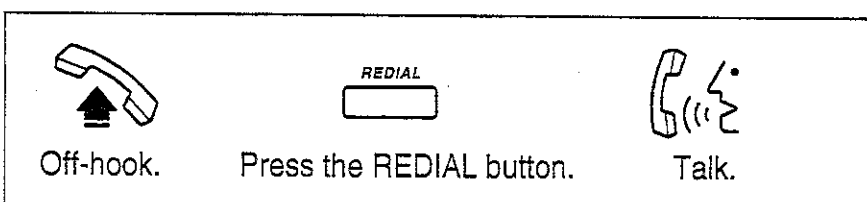

Receiving Calls

Receiving calls

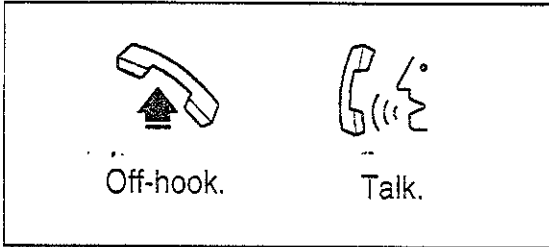

If your telephone rings,

- *Lift the handset or press the SP-PHONE/MONITOR button.*
(Default: The ringing line is selected.)
- *Press the rapid flashing green outside (CO) line button or rapid flashing INTERCOM button.*

Handsfree answerback

You can answer an intercom call without lifting the handset.
The AUTO ANSWER/MUTE button light shows the current status as follows.

- On:** Set
- Off:** Not set

To set / cancel

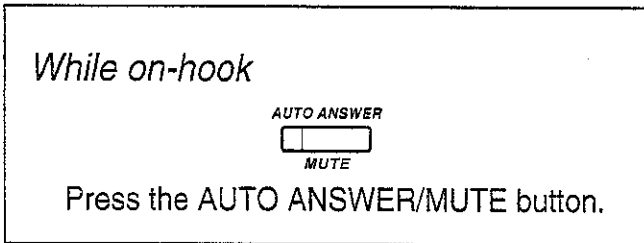

Picking up a call for someone else (Call Pickup)

You can answer an incoming call that is ringing at another extension from your telephone. A call within your extension group can be picked up.

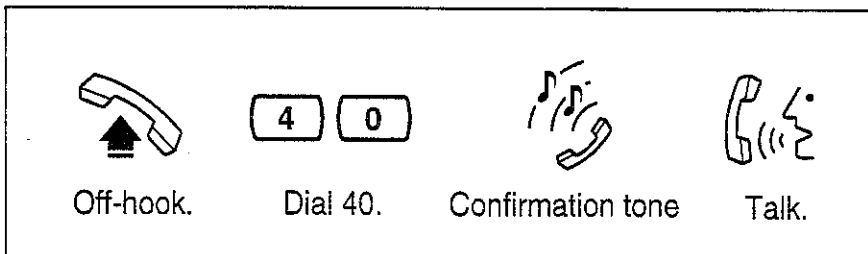



When the Dialed Extension is Busy/No Answer

Reserving a busy line (Automatic Callback Busy)

You can receive a notification when a busy extension becomes free. To answer the notification, lift the handset or press the SP-PHONE/MONITOR button. The called extension starts ringing automatically.

To set

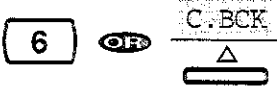
When hearing a busy tone

Dial 6 or press the C.BCK (S3) button.*¹ Confirmation tone On-hook.

To answer and call*²

If you hear call back ringing

 The extension is called automatically.

Off-hook.



*¹ The C.BCK (S3) button is only available for KX-T7433 and KX-T7436 users.
*² If you do not answer after four callback rings, this feature will be canceled.

Leaving a call notification (Message Waiting)

When the called extension is busy or does not answer, you can leave a notification to have the called extension call you back.





To leave a notification

When the called extension is busy or does not answer

Press the MESSAGE button. Confirmation tone On-hook.

To cancel a notification

Off-hook. Dial 700. Dial the extension number. Confirmation tone On-hook.

Calling Back

■ When you receive a notification (Message Waiting)

The MESSAGE button lights to let you know that a call has been received.

To check and select the party (display telephone only)

While on-hook



Press the MESSAGE button until the desired message appears.

To call back



Off-hook.



Press the MESSAGE button.



Talk.

To clear all notifications



Off-hook.



Dial 700.



Enter your extension number.



Confirmation tone



On-hook.

■ Calling using the call log (Incoming Call Log) (KX-T7433/KX-T7436 only)

If you do not answer a call, your telephone automatically records the incoming outside call information with the CLIP (Calling Line Identification Presentation) service*. You can also record the existing call during a conversation or call back the logged numbers. To confirm or call back using the call log, refer to pages 21 (for KX-T7433) and 23 (for KX-T7436).

* The CLIP service provides you with the caller's telephone number.

For more details, consult with your dealer.

To record the information of an existing call

During a conversation



Press the LOG (S2) button.

During a Conversation

Placing a call on hold

The corresponding outside (CO) line button or the INTERCOM button lights show the current status as follows.

Flashing green slowly: Your held call

Flashing red slowly: Another extension's held call

Holding

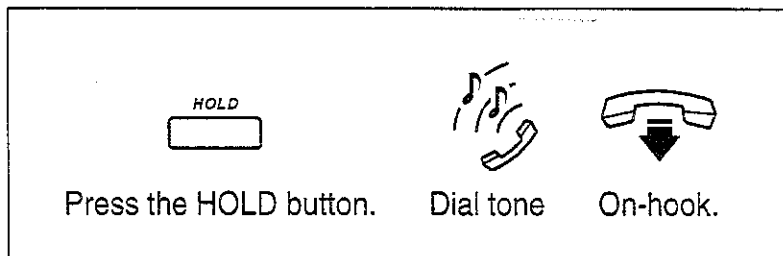

To retrieve a call at the holding extension*1

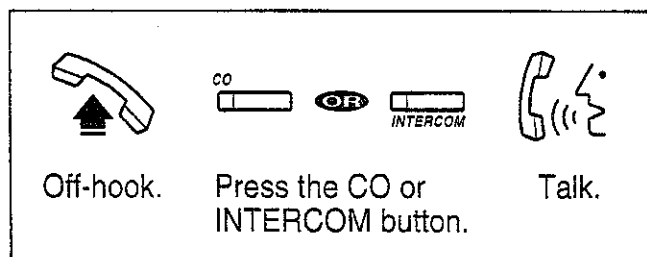

To retrieve an outside call from another extension*1

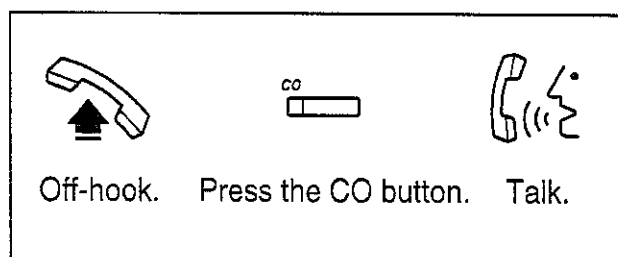

*1 *If a call is not retrieved within a specified time, you will hear an alarm as a reminder.*

Off-hook Monitor (KX-T7433/KX-T7436 only)

You can make other users listen to the conversation through the built-in speaker, while continuing the conversation using the handset.*2

To set

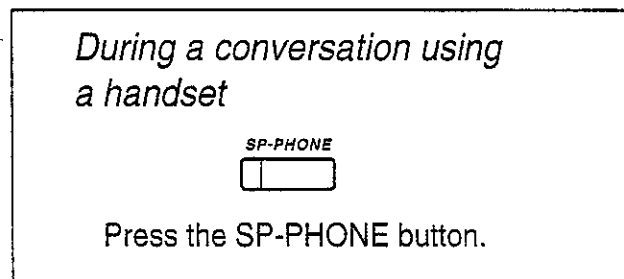

To cancel

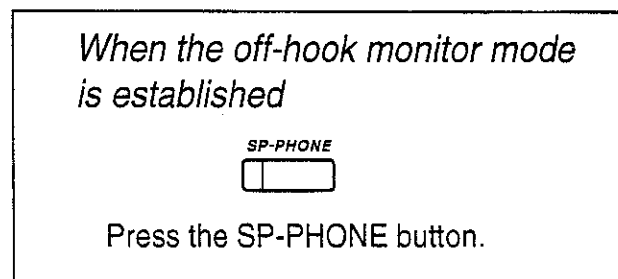

*2 *This is only available during a conversation with the handset.*



Transferring a call

Using the TRANSFER button

To an extension

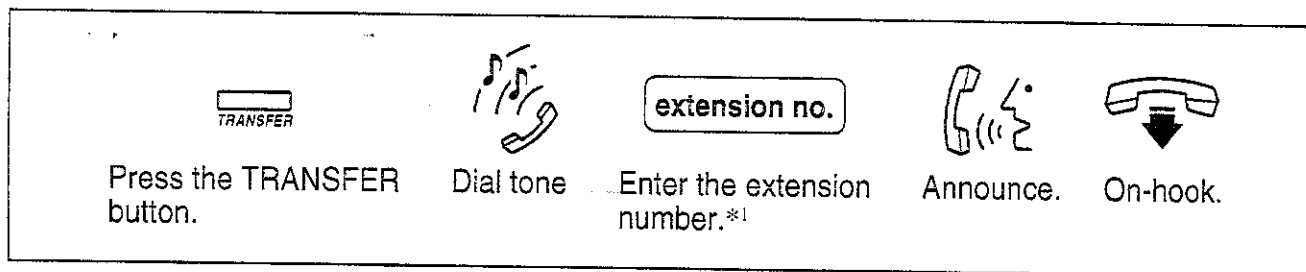

To an external party *²

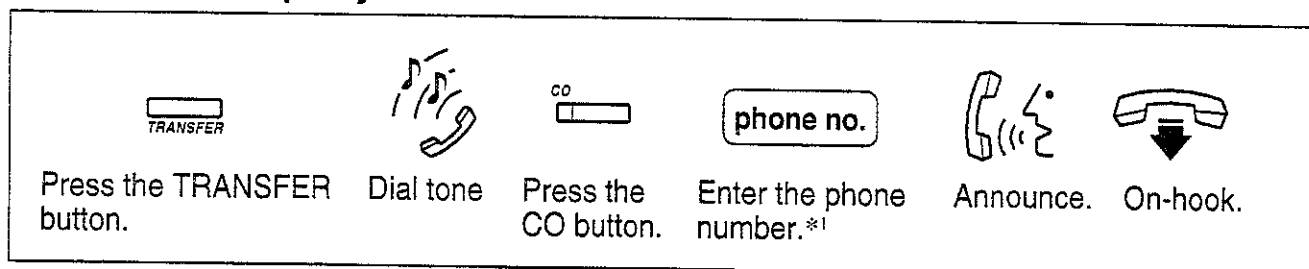

*¹ To retrieve the held call, press the TRANSFER button, corresponding Outside (CO) line button, or the INTERCOM button.

*² Transferring a call to an external party may be restricted by System Programming.

Through Paging

Refer to page 14, "Paging a person and transferring a call".

Paging



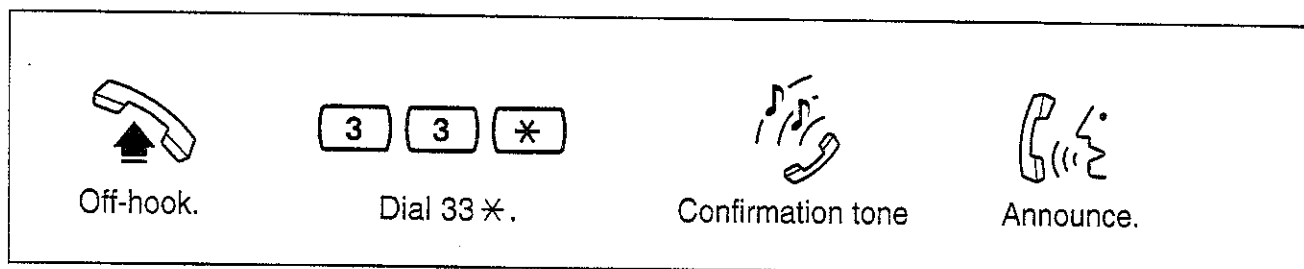

You can make a voice announcement to all people in the office through the telephone speaker and external speaker at the same time.



During a Conversation

Paging a person and transferring a call

During a conversation

Press the TRANSFER button.

Dial 33*.





Confirmation tone

Announce and wait for an answer.

On-hook.

Answering an announced page

Through a telephone speaker





Off-hook.

Dial 43.

Confirmation tone

Talk.

Through an external speaker

Off-hook.

Dial 42 and the external pager number.





Confirmation tone

Talk.

Answering a call waiting

During a conversation, a call waiting tone occurs when an outside call is received or another extension is letting you know that another call is waiting. (Default: Cancel)

To set / cancel

Off-hook.

To set: Dial 7311.



To cancel: Dial 7310.

Confirmation tone

On-hook.

To talk to the new party

While hearing a tone

Press the HOLD button.*¹ Press the CO or INTERCOM button.*²

- *¹ If you terminate the current call, disregard this step.
- *² If both parties are extensions, disregard this step.

Useful Features

■ Forwarding your calls (Call Forwarding)

You can have your incoming calls forwarded to another extension or external party.

All calls

All calls are forwarded to another extension.

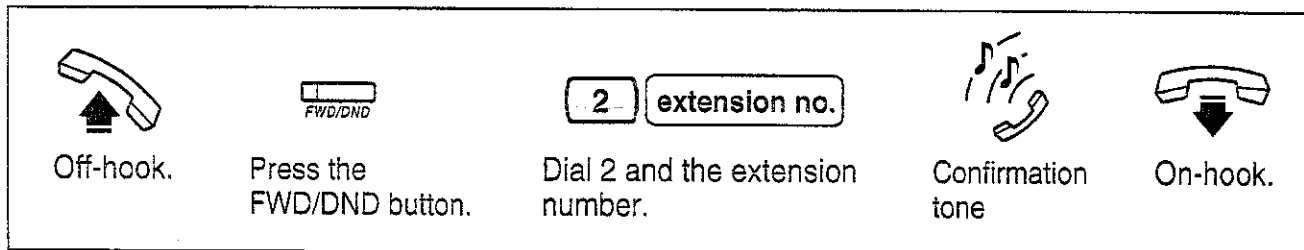

Busy

All calls are forwarded to another extension when your extension is busy.

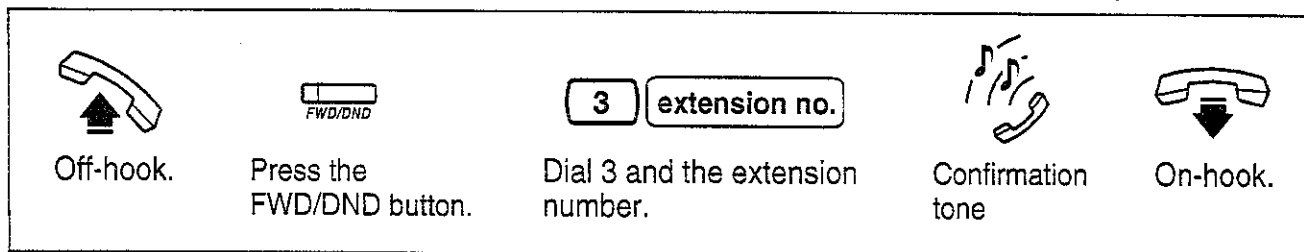

No answer

All calls are forwarded to another extension when you do not answer the call.

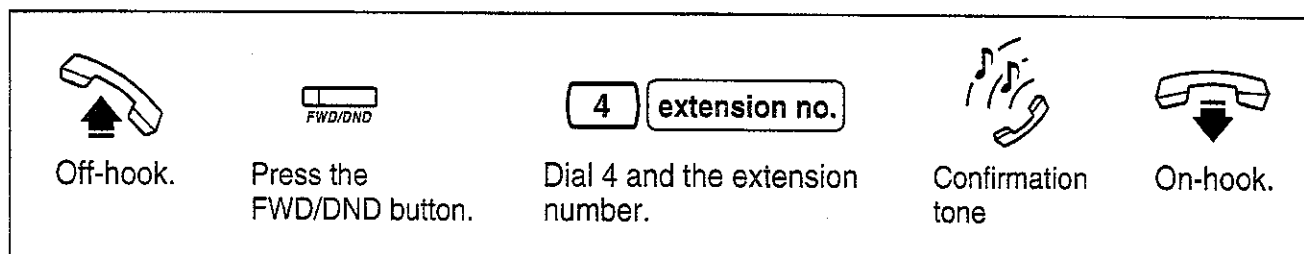

Busy/No answer (BSY/NA)



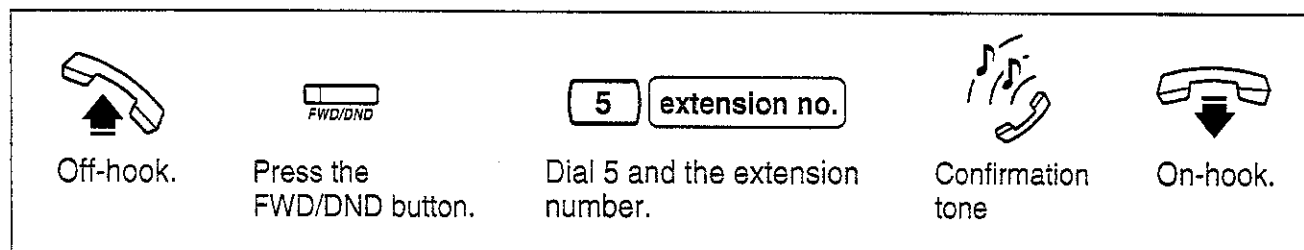





All calls are forwarded to another extension when you do not answer or when your extension is busy.



Useful Features

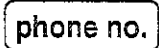





To outside (CO) line

All calls are forwarded to an external party. Some extensions may be restricted.





		   		
Off-hook.	Press the FWD/DND button.	Dial 69, the phone number and #.	Confirmation tone	On-hook.

Follow Me (From)







All calls are forwarded to another extension which you set to receive your calls at the receiving extension.

		 		
Off-hook.	Press the FWD/DND button.	Dial 7 and your extension number.	Confirmation tone	On-hook.

Canceling (except Follow Me)

				
Off-hook.	Press the FWD/DND button.	Dial 0.	Confirmation tone	On-hook.





Canceling Follow Me

		 		
Off-hook.	Press the FWD/DND button.	Dial 8 and your extension number.	Confirmation tone	On-hook.



Preventing others from disturbing you (Do Not Disturb [DND])

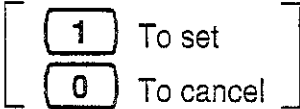
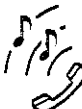



During a meeting or when you are busy, you can refuse an incoming call.

				
Off-hook.	Press the FWD/DND button.	To set: Dial 1. To cancel: Dial 0.	Confirmation tone	On-hook.

Three-party conversation (Conference)





You can add another party during a conversation.

Adding a third party during a conversation

				
Press the CONF button.	Enter the third party's number.*1	Talk to the third party.	Press the CONF button.	Confirmation tone

*1 To add an external party, press an outside (CO) line button and dial the phone number.

To talk to one party by terminating the other

			
Press the CO or INTERCOM button.*2			Confirmation tone

Leaving a conference

On-hook.







*2 This is only available for a combination of one extension and two outside (CO) lines or two extensions and one outside (CO) line.

Useful Features

■ Ringing tone selection for CO buttons

You can select the desired ringer frequency for each outside (CO) line button.

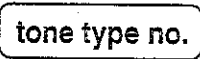





To program

	 	 			
Press the PROGRAM button.	Dial 99.	Press the desired CO button twice.	Enter the tone type number (1 through 8).	Press the AUTO DIAL/STORE button.	Press the PROGRAM button.

■ Storing numbers for One-touch dialing

The stored number is dialed automatically by pressing an outside (CO) line button which is assigned as a one-touch dialing button.

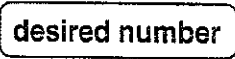
To program

	 					
Press the PROGRAM button.	Dial 99.	Press the desired CO button.	Dial 2.	Enter the desired number.	Press the AUTO DIAL/STORE button.	Press the PROGRAM button.

How to Use the Display

■ Using the Jog Dial

Using the display message and the Jog Dial, KX-T7433, KX-T7436 users can make a call or operate the features without programming the feature numbers.

Extension Dialing	You can make an intercom call using the directory.	Only items which have a name assigned are displayed in alphabetical order.
System Speed Dialing	You can make a call to a party stored in the system using the directory.	
Station Speed Dialing	You can make a call to a party stored in your telephone using the directory.	Items which have a name assigned are displayed by priority in stored order. If a name is not assigned, the number is displayed.
System Feature Access	You can access the features which are displayed in alphabetical order.*	

** For more details about the accessible features, refer to your Digital Super Hybrid system manual or consult with your dealer.*

How to Use the Display

KX-T7433

Operating the feature

1 Press the **SHIFT** button repeatedly to set the display to the third display.

- 2 Select the desired feature.*
- Press the **STA** (S1) button (for Station Speed Dialing).
 - Press the **EXT** (S2) button (for Extension Dialing).
 - Press the **FEAT** (S3) button (for System Feature Access).

3 Rotate the **Jog Dial** until the desired item is at the arrow on the display.

- 4 • Press the **CALL** (S3) button (for System Speed Dialing, Station Speed Dialing and Extension Dialing).
- Press the **SEL** (S3) button (for System Feature Access).

5 Enter a parameter, if required or follow the procedure for standard operation (for System Feature Access only).

* Step 2 can be skipped for System Speed Dialing.

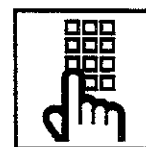
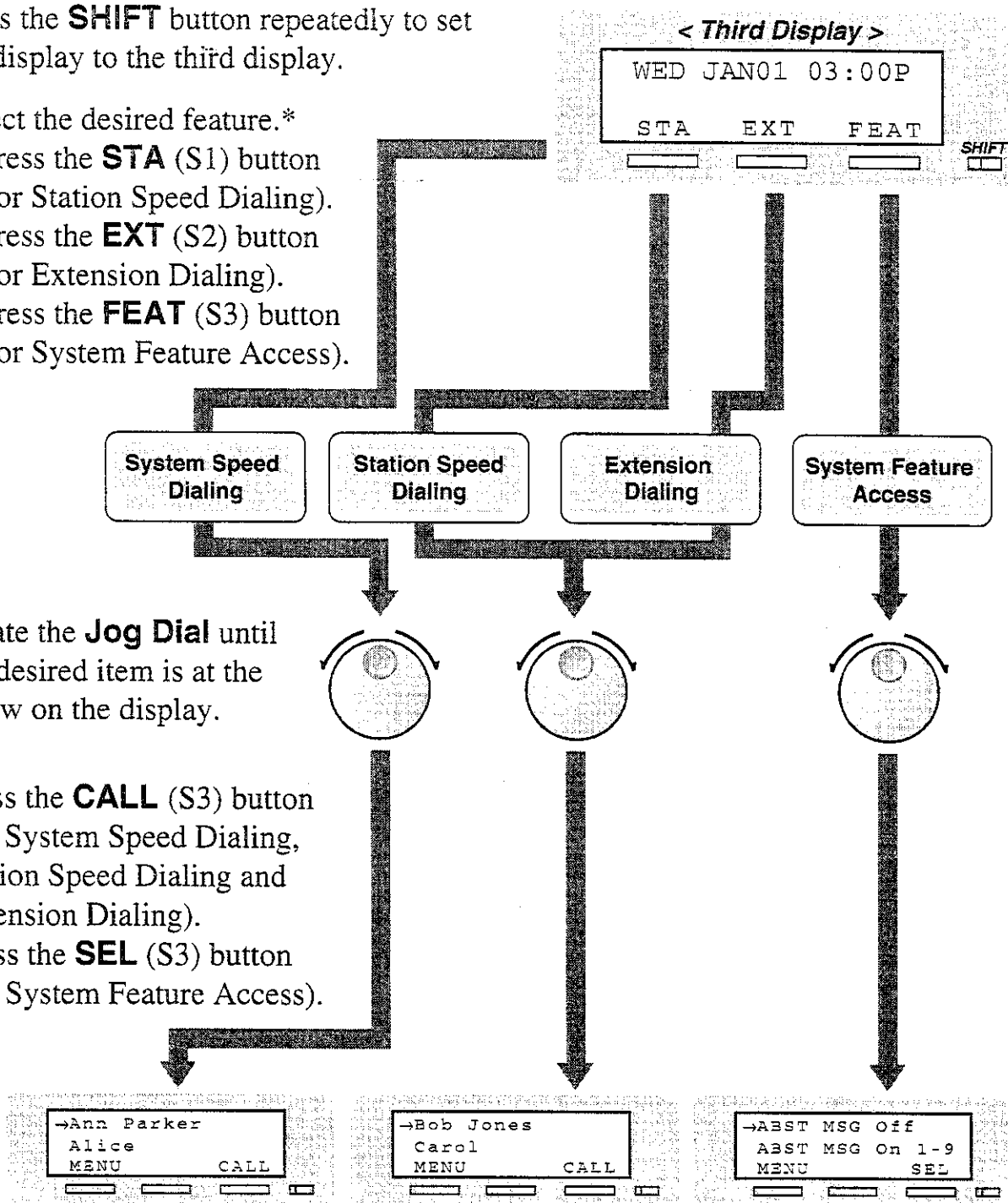



Confirming and calling back using the call log

- 1 Press the **SHIFT** button to set the display to the second display.
- 2 Select the desired call log.
 - Press the **OLD** (S1) button to see the confirmed information.
 - Press the **NEW** (S2) button to see the unconfirmed information.
- 3
 - Press the **INFO** (S1) button to see the information in detail.
 - Press the **NEXT** (S3) button to see another caller's information.

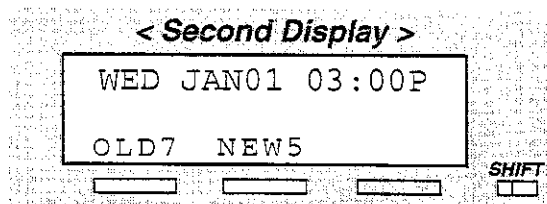

The sequence number and caller's number are displayed.

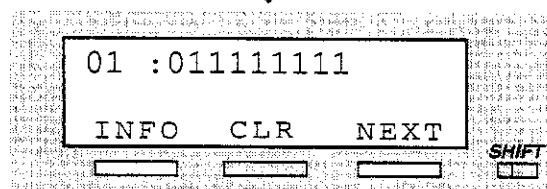

Pressing the INFO button provides you with more information.

- Once: sequence number/caller's name
- Twice: date/time/number of times called (30 times max.)
- Three times: outside line number /outside line name

To see another caller's information

- 4 Off-hook.



- 5 Press the **CALL** (S1) button.

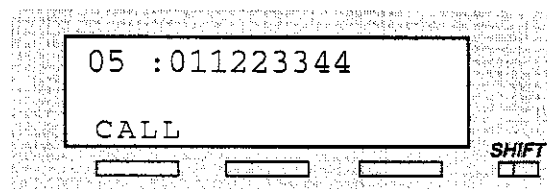

How to Use the Display

KX-T7436

Operating the feature

- 1 Press the **SHIFT** button repeatedly to set the display to the third display.
- 2 Select the desired feature.*
 - Press the **STA** (S1) button (for Station Speed Dialing).
 - Press the **EXT** (S2) button (for Extension Dialing).
 - Press the **FEAT** (S3) button (for System Feature Access).

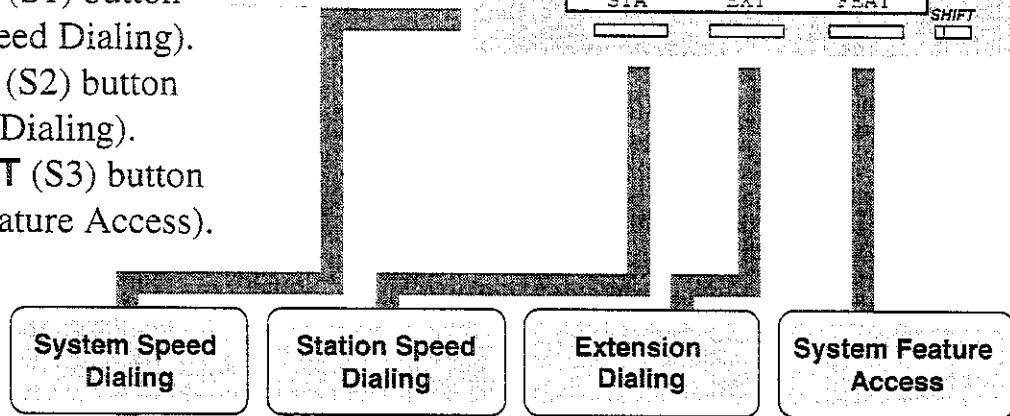
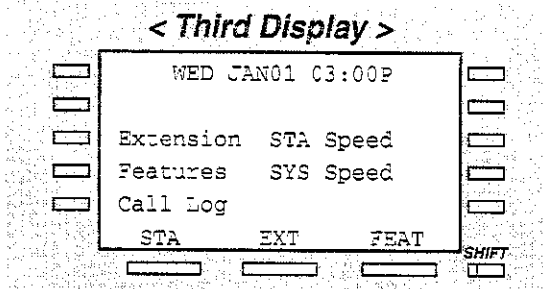

- 3 Rotate the **Jog Dial** until the desired item is at the arrow on the display.
- 4 • Press the **CALL** (S3) button (for System Speed Dialing, Station Speed Dialing and Extension Dialing).
- Press the **SEL** (S3) button (for System Feature Access). Or press the corresponding buttons on the side of the display (Function button).

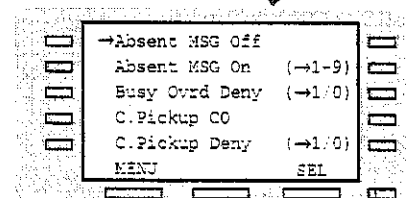
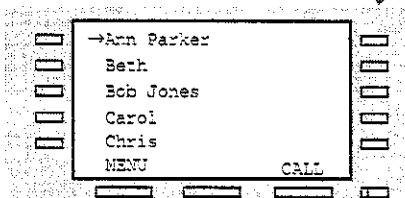
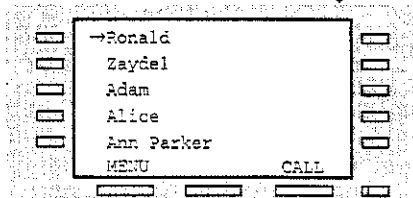
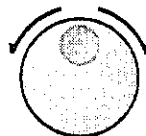
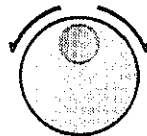

If a parameter is required, the parameter will flash.

- 5 Enter a parameter if required or follow the procedure for standard operation (for System Feature Access only).

* Step 2 can be skipped for System Speed Dialing.

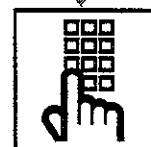

Confirming and calling back using the call log

- 1 Press the **SHIFT** button to set the display to the second display.
- 2 Select the desired call log.
 - Press the Function button (call log) to call a number previously dialed (for the outgoing call log).
 - Press the **OLD** (S1) button to see the confirmed call information you received.
 - Press the **NEW** (S2) button to see the unconfirmed call information you received.

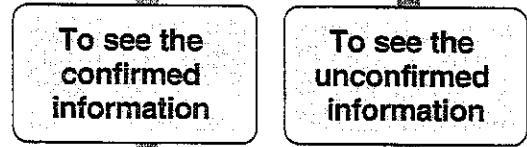
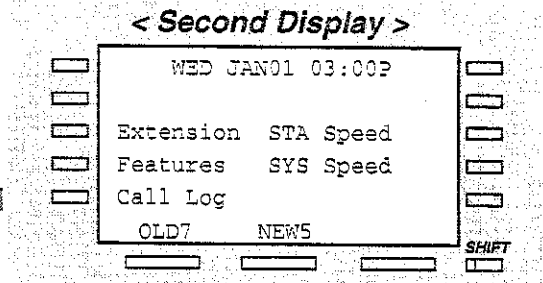

- 3 Press the **NEXT** (S3) button to see another caller's information.*

Outside line number/name
 Caller's telephone number
 Caller's name
 Date and time
 Sequence number (01-30)
 /number of times called
 (30 times max.)

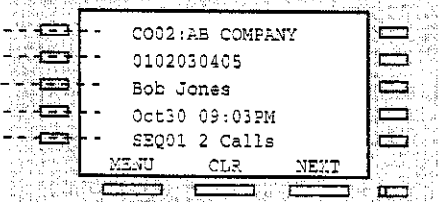

Call Log, Outgoing
 To make a call using the call log (last five outside calls you dialed).

To see another caller's information

- 4
 - Press the corresponding button on the side of the display (for the outgoing call log).
 - Off-hook (for the incoming call log).

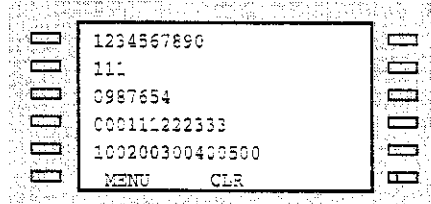

- 5 Press the **CALL** (S1) button.*

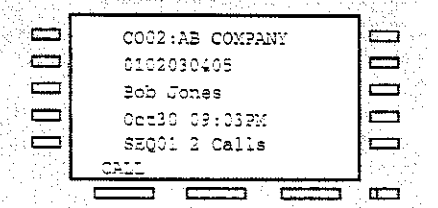

* Step 3 and 5 can be skipped for the outgoing call log.

Storing in Speed Dialing

Storing names and numbers at your extension for personal use

To store a phone number

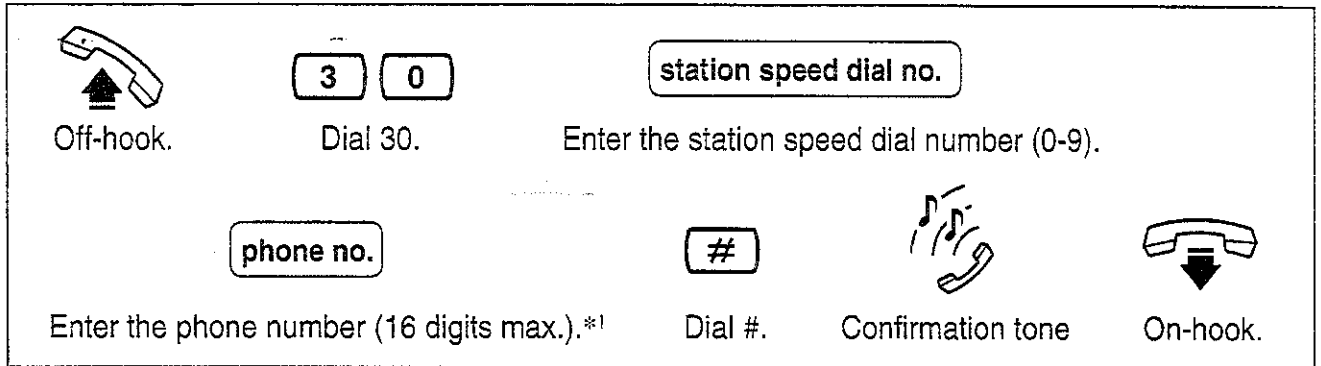

1 “” and PAUSE can be also stored as digits.

To store a phone number

– For KX-T7433 users

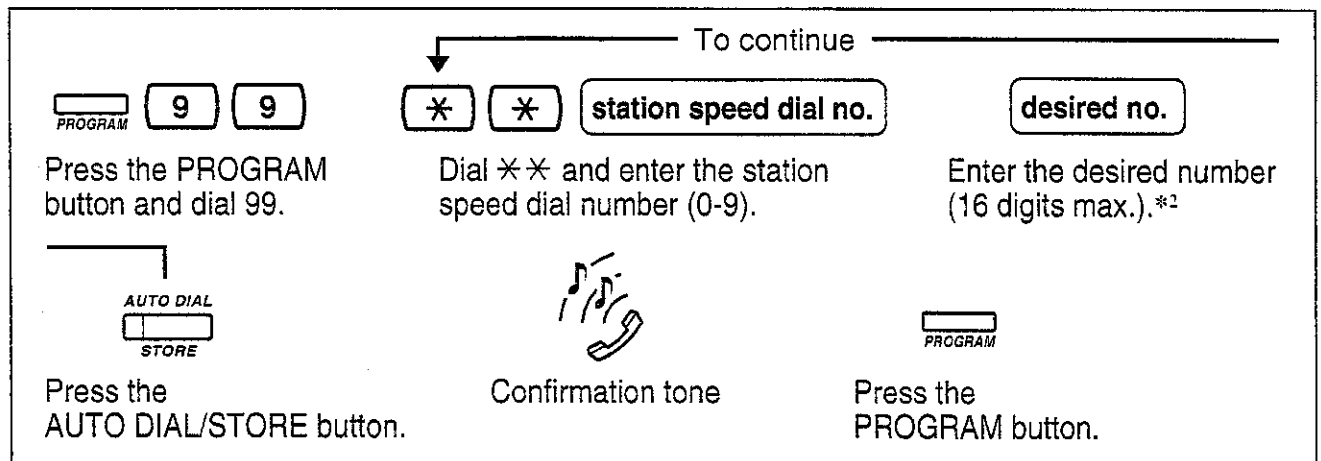

– For KX-T7436 users

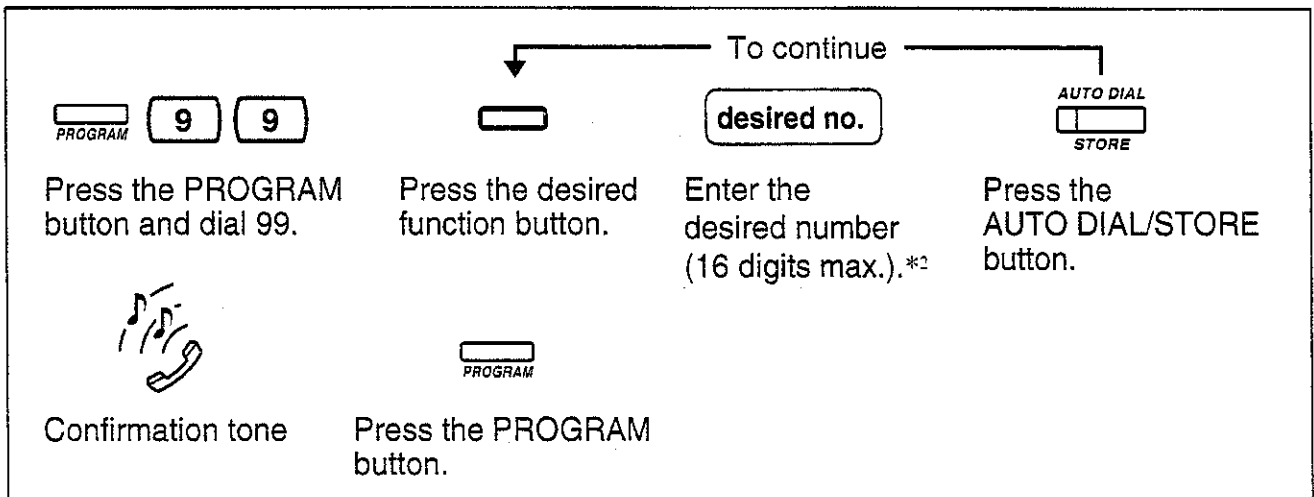

2 “”, “#”, FLASH, SECRET (INTERCOM), -(CONF) and PAUSE can be also stored.



To store a name

– For KX-T7433 users

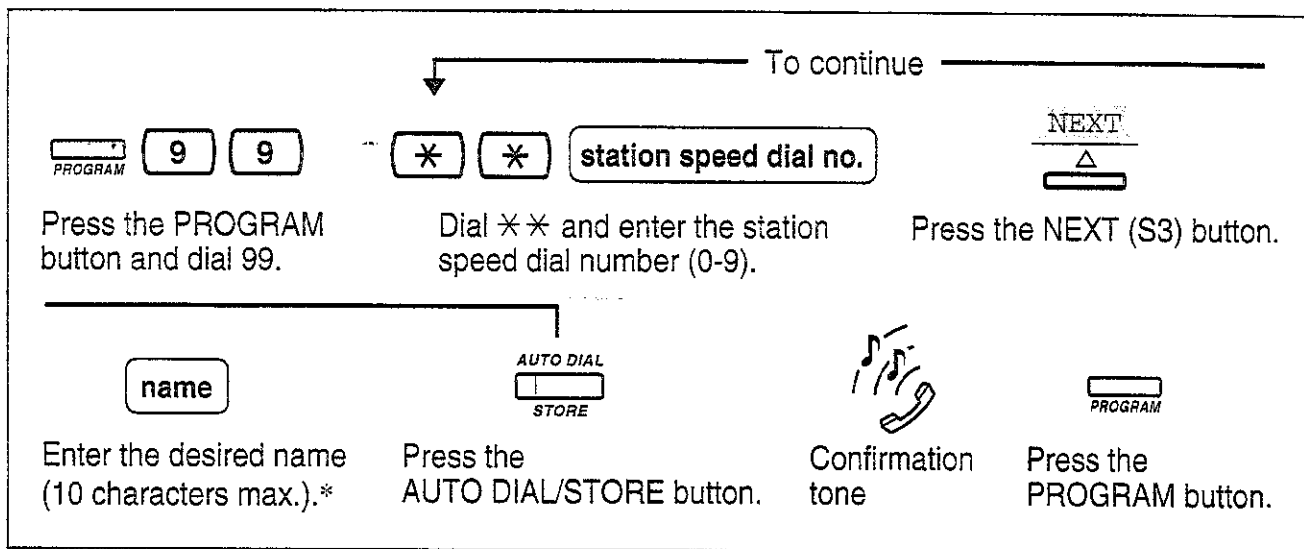

– For KX-T7436 users

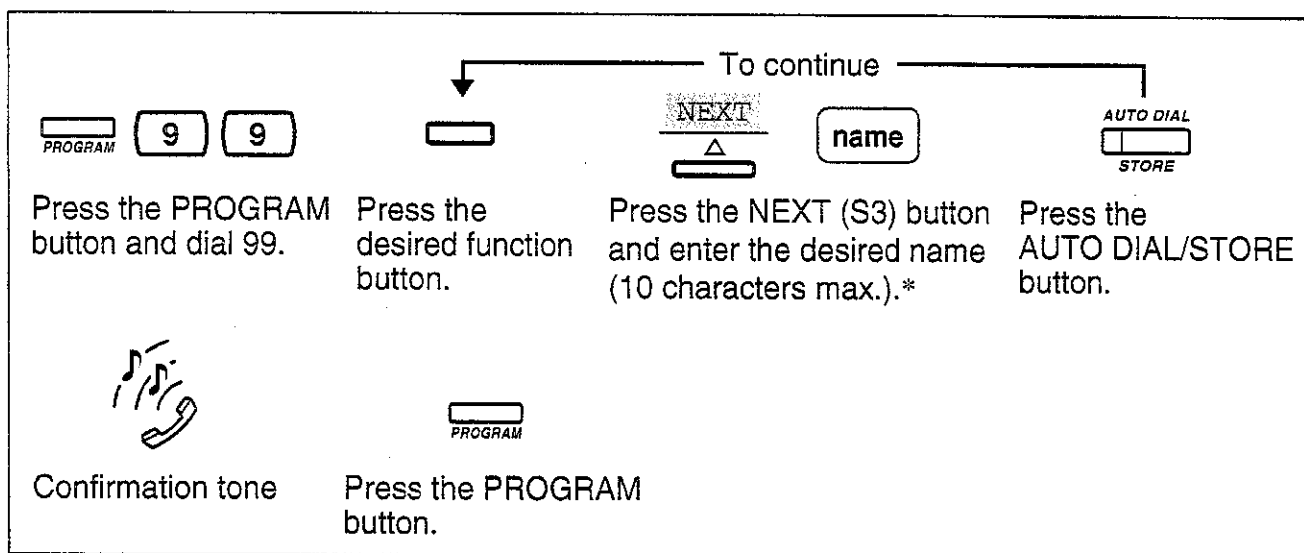

* To enter characters, press 2 and rotate the Jog Dial to select the character.
 You can continue entering characters by pressing 2 and using the jog dial repeatedly.
 To correct a wrong entry, press the TRANSFER button and enter the new one.

Example: To enter “Mike”

- 1 Press 2, rotate the Jog Dial to enter “M”.
- 2 Press 2, rotate the Jog Dial to enter “i”.
- 3 Press 2, rotate the Jog Dial to enter “k”.
- 4 Press 2, rotate the Jog Dial to enter “e”.









Storing in Speed Dialing

Storing names and numbers in the system

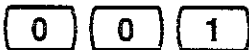

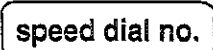
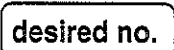





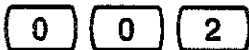

(KX-T7433/KX-T7436 only)

As the stored numbers can be used by all of the users in the system, confirm the stored entries with other users.

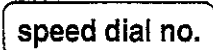
To store a phone number

 PROGRAM		User Password	
Press the PROGRAM button.	Dial **.	Enter the user password.	Dial 001.
			
Press the SP-PHONE or NEXT (S3) button.	Enter the speed dial number (000-499).	Enter the desired number (24 digits max.).	
			
Press the AUTO DIAL/STORE button.	Confirmation tone*	Press the HOLD button.	Press the PROGRAM button.

To store a name

 PROGRAM		User Password	
Press the PROGRAM button.	Dial **.	Enter the user password.	Dial 002.
			
Press the SP-PHONE or NEXT (S3) button.	Enter the speed dial number (000-499).	Enter the desired name (10 characters max.).	
			
Press the AUTO DIAL/STORE button.	Confirmation tone*	Press the HOLD button.	Press the PROGRAM button.

* You can continue entering the number/name by pressing the NEXT (S3) or SP-PHONE button after the confirmation tone.

Wall Mounting

- 1** Remove the handset hook by pulling it toward the top of the unit. Turn it around and re-insert it.

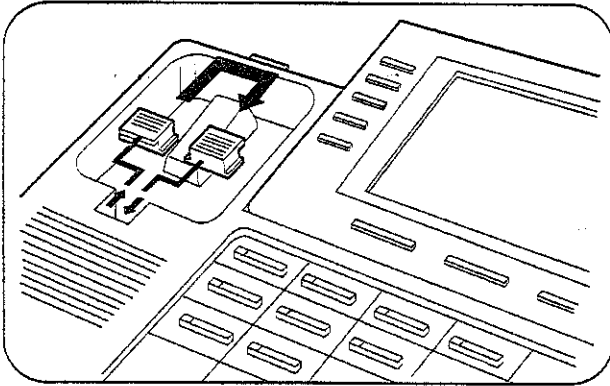

- 2** Remove the attached stand.

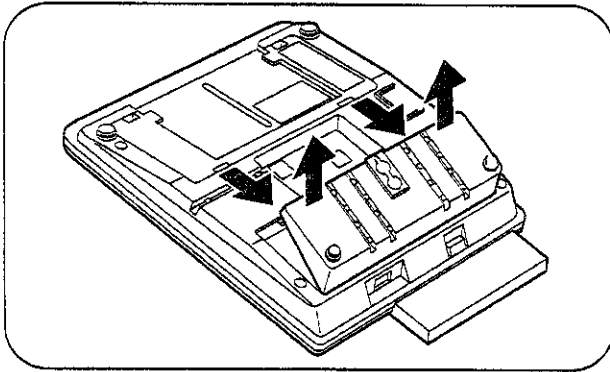

- 3** Turn it around 180 degrees.

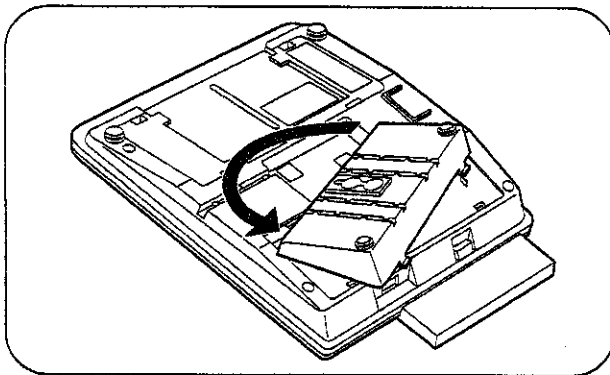

- 4** Insert the stand in the center slots.

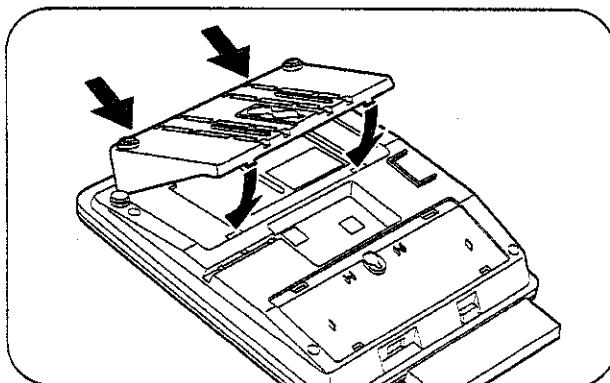

- 5** Insert the included telephone line and handset cords. (Ensure the cords are inserted in the grooves to prevent damage to the connectors.)

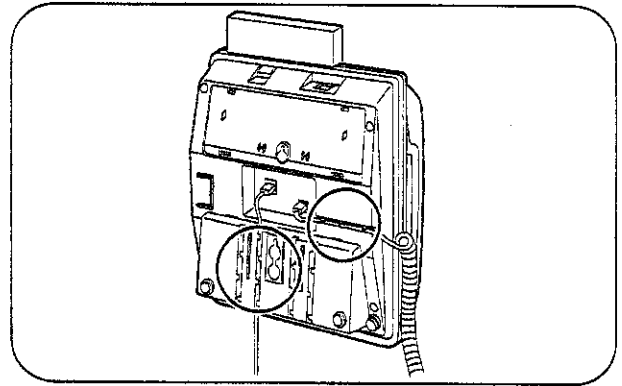

- 6** Mount the unit on the wall.

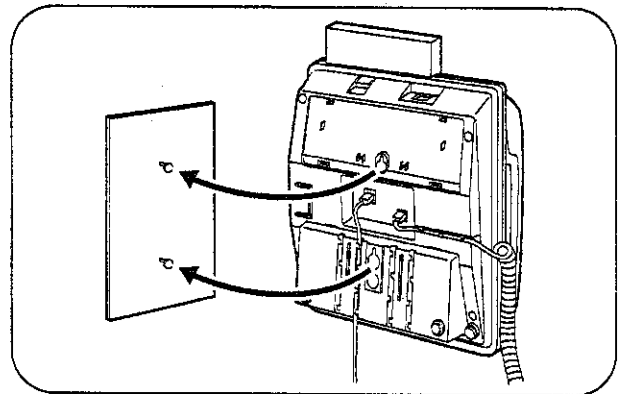

To temporarily place the handset down during a conversation, hook it over the top edge of the phone as shown.

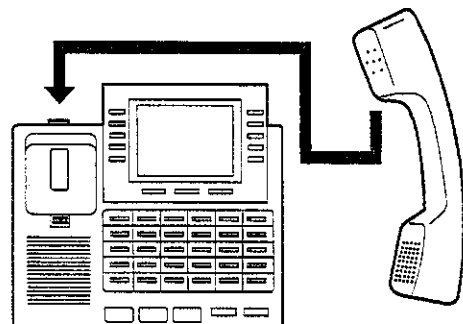

* The illustrations used in this page are a KX-T7436.

Installing the Card Holder

The KX-T7425 is equipped with a card holder with memory station card. Follow the instructions below to install the card holder to the unit.

- 1 Place the card holder edges so that they can be inserted under the slide rails on the unit.

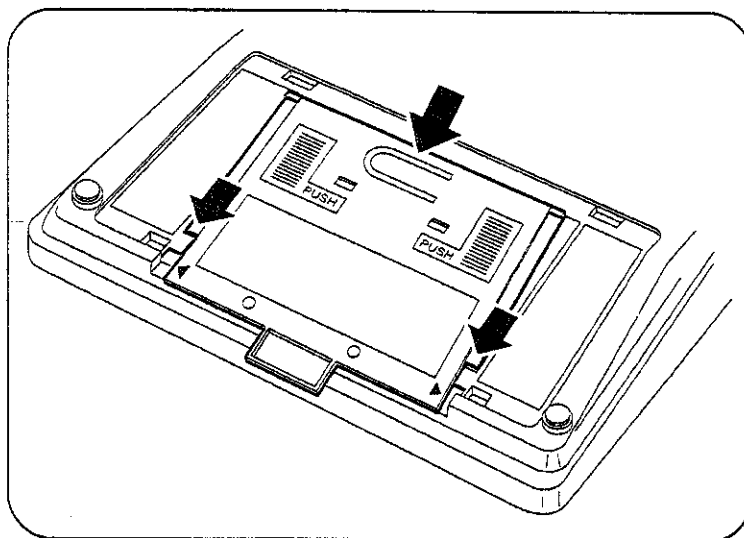

- 2 While pushing on the areas marked "PUSH", insert the edges of the holder under the slide rails and then slide in the direction of arrow (A).

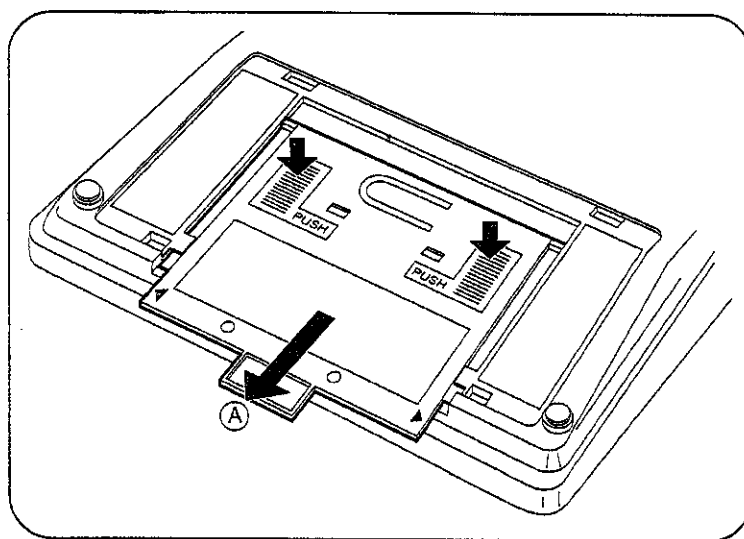

Remove the card holder:

Push the card holder in the direction of arrow (B). Then, while pressing on the tab, pull the top of the holder in the direction of arrow (C).

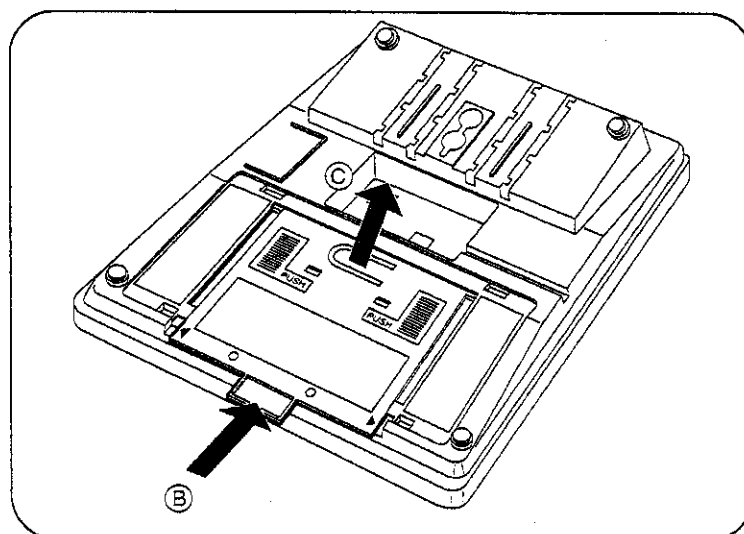

Features List

Desired Function	Operation				
Setting Absent Message	▶ 7 5 0 ▶ message no. ▶				
Account Code Entry	▶ 4 9 ▶ account code + # ▶ 9 / ▶ phone no.				
Sending a Call Waiting tone (BSS)	1 ▶ Wait for an answer. ▶				
Forwarding a call	▶ ▶ <div style="border: 1px dashed black; padding: 5px; display: inline-block;"> <p>All Calls 2 ▶ extension no.</p> <p>Busy 3 ▶ extension no.</p> <p>No Answer 4 ▶ extension no.</p> <p>Busy / No Answer 5 ▶ extension no.</p> <p>To Outside Line 6 9 ▶ phone no. ▶ #</p> <p>Follow Me 7 ▶ your extension no.</p> <p>Cancel 0</p> <p>Cancel Follow Me 8 ▶ your extension no.</p> </div>				
Holding a call	Holding ▶	To retrieve a call at the holding extension ▶ ▶			
Holding a call exclusively	Holding ▶ ▶	To retrieve a call on exclusive hold ▶ ▶			
Parking a call in the system	▶ 5 2 ▶ parking zone no. ▶				
Picking up a call	▶ 4 0 ▶				
Transferring a call	▶ <table style="display: inline-table; border: 1px solid black; padding: 5px;"> <tr> <td style="padding: 2px 5px;">extension no.</td> <td style="padding: 2px 5px;">to an extension</td> </tr> <tr> <td style="padding: 2px 5px;"> phone no.</td> <td style="padding: 2px 5px;">to an external party</td> </tr> </table> ▶ ▶ ▶ <p style="text-align: center;">Announce.</p>	extension no.	to an extension	phone no.	to an external party
extension no.	to an extension				
phone no.	to an external party				
Call Waiting	▶ <table style="display: inline-table; border: 1px solid black; padding: 5px;"> <tr> <td style="padding: 2px 5px;">7 3 1 1</td> <td style="padding: 2px 5px;">Set</td> </tr> <tr> <td style="padding: 2px 5px;">7 3 1 0</td> <td style="padding: 2px 5px;">Cancel</td> </tr> </table> ▶	7 3 1 1	Set	7 3 1 0	Cancel
7 3 1 1	Set				
7 3 1 0	Cancel				
Three-party conference	▶ third party's no. ▶ ▶				

Features List

Desired Function		Operation								
Paging		▶ 3 3 * All extensions & external speaker ▶ Announce.								
Do Not Disturb (DND)		▶ ▶ <table border="1"> <tr> <td>1</td> <td>Set</td> </tr> <tr> <td>0</td> <td>Cancel</td> </tr> </table> ▶	1	Set	0	Cancel				
1	Set									
0	Cancel									
Locking your extension		▶ <table border="1"> <tr> <td>7 7</td> <td>lock code</td> <td>lock code</td> <td>Lock</td> </tr> <tr> <td>7 7</td> <td>lock code</td> <td></td> <td>Unlock</td> </tr> </table> ▶	7 7	lock code	lock code	Lock	7 7	lock code		Unlock
7 7	lock code	lock code	Lock							
7 7	lock code		Unlock							
Clearing the setting		▶ 7 9 0 ▶								
Message Waiting	Sender	To leave a notification ▶ To cancel a notification ▶ 7 0 0 ▶ extension no. ▶								
	Receiver	To call back ▶ ▶ To clear all notifications ▶ 7 0 0 ▶ receiver's extension no. ▶								
Calling an operator		▶ 0 ▶								
Connecting an SLT in parallel		▶ <table border="1"> <tr> <td>3 9 1</td> <td>Set</td> </tr> <tr> <td>3 9 0</td> <td>Cancel</td> </tr> </table> ▶	3 9 1	Set	3 9 0	Cancel				
3 9 1	Set									
3 9 0	Cancel									
Calling a pre-programmed party (Pickup Dialing)		To store ▶ 7 4 2 ▶ phone no. ▶ # ▶ To set / To cancel ▶ <table border="1"> <tr> <td>7 4 1</td> <td>Set</td> </tr> <tr> <td>7 4 0</td> <td>Cancel</td> </tr> </table> ▶ To dial 	7 4 1	Set	7 4 0	Cancel				
7 4 1	Set									
7 4 0	Cancel									
Speed dialing (Station)		To set ▶ 3 0 ▶ station speed dial no. ▶ phone no. ▶ # ▶ To dial ▶ 3 * ▶ station speed dial no. ▶								
Speed dialing (System)		▶ ▶ system speed dial no. ▶								

* Some feature numbers can be changed by System Programming.
For more details, consult with your dealer.

For your future reference

SERIAL NO. _____ DATE OF PURCHASE _____
(found on the bottom of the unit)

NAME OF DEALER _____

DEALER'S ADDRESS _____